

zappi

eco-smart EV charge point



Operation & Installation Manual

MODELS:

ZAPPI-2H07UW

ZAPPI-2H22UW

ZAPPI-2H07UB

ZAPPI-2H22TW

ZAPPI-2H07TW

ZAPPI-2H22UB

ZAPPI-2H07TB

ZAPPI-2H22TB



Rev 2.1.3 January 2022 - ENGLISH

Contents

Introduction.....	4
Safety	4
Box Contents	5
Overview.....	5
Operation	7
Controls & Indicators.....	7
Display.....	8
Status Screens.....	10
Charging Modes	12
Manual Boost	13
Smart Boost.....	13
Boost Timer	15
Lock Function	16
Menus.....	18
Main Menu.....	18
Advanced Menu.....	22
Configuration Settings	24
Time & Date	24
Display & Sound	24
RGB LED	24
Grid Limit.....	24
CT Detect (“G100”)	24
Advanced Settings.....	25
Supply Grid – Device Settings	25
Supply Grid – Network Settings.....	26
CT Config.....	27
Preconditioning.....	29
eSense	31
Linking Devices	31
Wireless Connection.....	34
Ethernet Connection	35
Installation.....	36
Electrical Installation.....	38
Wiring.....	39
eSense Input.....	41
Wiring Overview Diagram	42
CT Sensor Installation.....	43
CT Golden Rules.....	45
Fitting the Cover	46
Advanced Installation Options	47
Built-in Protection	49
Setup	51
Troubleshooting.....	52
Faults.....	53
Warranty.....	54
Product Registration.....	54
Technical Specifications	55
myaccount	58
The myenergi app.....	58
The myenergi forum	58
Technical Support.....	58
Declaration of Conformity	59

Introduction

Introduction

Thank you for choosing zappi. Of course, we think you have made an excellent choice and are sure you will be incredibly happy with the features, benefits, and quality of your myenergi product.

These instructions will help you to familiarise yourself with the zappi. By reading the instructions, you will be sure to get the maximum benefit from your 'eco-smart' device.

Safety

zappi is an AC EV charger, intended to be installed in a fixed location and permanently connected to the AC supply network. It is a Class 1 item of electrical equipment in accordance with IEC 61140.

The unit is designed for indoor or outdoor use at a location with restricted access and should be mounted vertically either surface (wall) mounted or on the dedicated pole mount supplied separately by myenergi.

The device has been manufactured in accordance with the state of the art and the recognised safety standards, however, incorrect operation or misuse may result in:

- Injury or death to the operator or third parties
- Damage to the device and other property of the operator
- Inefficient operation of the device

All persons involved in commissioning, maintaining, and servicing the device must:

- Be suitably qualified
- Have knowledge of and experience in dealing with electrical installations
- Read and follow these operating instructions carefully
- Always disconnect the device from the supply before removing the cover

The device is not to be used by persons (including children) with reduced physical, sensory, or mental capabilities, or lack of experience and knowledge, unless they have been given supervision or instruction concerning use of the device by a person responsible for their safety.

zappi comes in either tethered or untethered variants. The untethered version should only be used with a dedicated cable fitted with a Type 2 plug which is compliant with EN 62196-1 and EN 62196-2. Adaptors or conversion adaptors and cord extension sets are not allowed to be used.

Failure to install and operate the zappi in accordance with these instructions may damage the unit and invalidate the manufacturer's warranty.

Disposal

In accordance with European Directive 2002/96/EC on waste electrical and electronic equipment and its implementation in national law, used electrical devices **must** be collected separately and recycled in an environmentally responsible manner. Ensure that you return your used device to your dealer or obtain information regarding a local, authorised collection and disposal system. Failure to comply with this EU Directive may result in a negative impact on the environment.

Copyright

Copyright of these operating instructions remains with the manufacturer. Text and images correspond to the technical level at the time of going to press. We reserve the right to make changes. The content of the operating instructions shall not give rise to any claims on the part of the purchaser. We are grateful for any suggestions for improvement and notices of errors in the operating instructions.

myenergi zappi, myenergi eddi and myenergi harvi are registered trademarks of myenergi Ltd.

Box Contents

Tethered Units

1 x zappi unit with EV cable and connector attached
 1 x Cable wall guard
 1 or 3 x CT clamps¹
 1 x Mounting template
 1 x Mounting kit for a brick wall

Mounting kit (Tethered units)

4 x 50mm Pozi screws
 4 x Wall mounting plug
 4 x Sealing washer
 4 x 12mm Pozi screws (countersunk)

Untethered Units

1 x zappi unit
 1 or 3 x CT clamps¹
 1 x Mounting template
 1 x Mounting kit for a brick wall

Mounting kit (Untethered units)

4 x 50mm Pozi screws
 4 x Wall mounting plug
 4 x Sealing washer

Overview

Microgeneration systems such as Solar PV and small wind turbines are at their most efficient when the generated energy is consumed on-site rather than exporting it to the grid. This is what we call 'self-consumption'.

zappi is a Mode 3 charging station, compatible with all electric vehicles that comply with EN 62196 and EN 61851-1 plug-in electric vehicle standards.

zappi works like any regular charging point but has special ECO charging modes that will benefit homeowners with grid-tied microgeneration systems e.g. wind or solar generation. Two special ECO charging modes automatically adjust charging current in response to on-site generation and household power consumption. In FAST charge mode, zappi operates like an ordinary EV charger.

A grid current sensor (supplied) simply clips around the incoming supply cable and is used to monitor excess power. When using the special ECO charge modes, zappi will automatically adjust the charge rate in response to available surplus.

Feature Set

- 3 charging modes: ECO, ECO+ & FAST
- Optimises microgeneration self-consumption
- Works with solar PV, wind turbine or micro-hydro systems
- Economy tariff sense input
- Programmable timer function
- Charge and event logging
- Remote control and monitoring add-on option
- Pin-code lock function
- Tap operated display backlight
- Built-in 30mA Type A RCD + 6mA DC RCD protection (EN 62955)
- Built-in protection against the loss of the protective neutral and earth (PEN) conductor as required by BS 7671:2018 Amendment 1:2020(The "Wiring Regulations")
- Ethernet connector (for local communications between myenergi devices)
- Integral cable holster (tethered units)
- Supplied with 1 x clip-on grid current sensor (x3 if purchasing a 3-phase unit)
- Illuminated display – for convenience, the display can be illuminated by simply tapping the zappi front cover.
- Integrated WiFi for connecting to internet.

¹ 1xCT clamp supplied with single phase zappi; 3xCT clamps supplied with three phase zappi

Overview

Overview Diagram

The diagram below shows the zappi as part of a complete energy management system. Other myenergi products are shown with details of how they integrate with the grid connection and the microgeneration system.

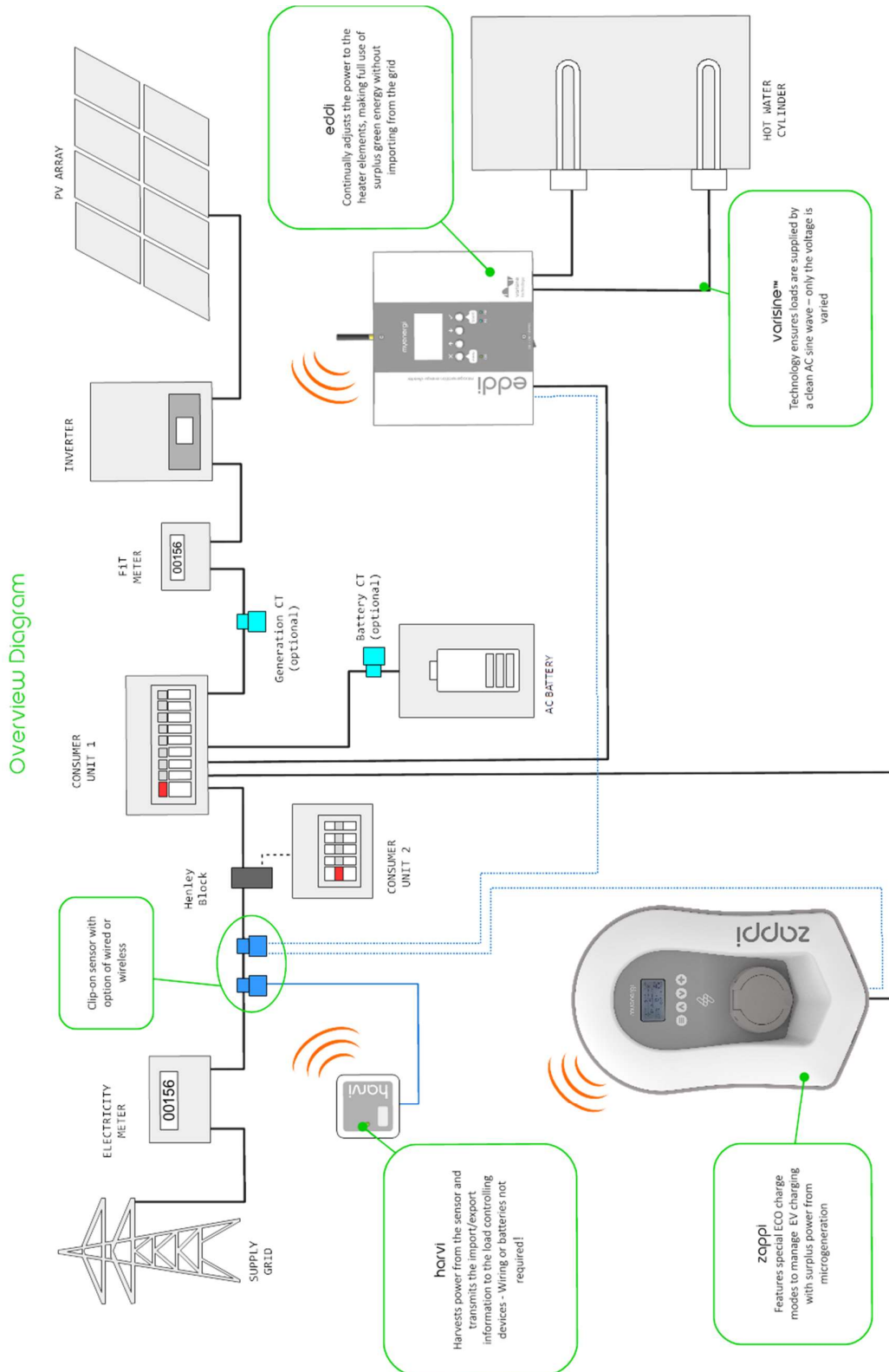

Operation

Controls & Indicators



1.	Display	Graphical LCD display with LED backlight <ul style="list-style-type: none"> Backlight can be activated by tapping the unit.
2.	Front Fascia	Remove fascia for installing and servicing
3.	Tethered Charging Cable if applicable	6.5-meter cable with a Type 2 plug or Type 2 socket with locking system for untethered models.
4.	Control Buttons	Four tactile buttons used to navigate the menus and alter settings: <ul style="list-style-type: none"> Menu Change charge mode Move up a menu item Increase value Change charge mode Move down a menu item Decrease value Boost Select item Confirm value and move to next setting.
5.	Integrated Cable Holster (tethered units only)	When not in use, the charging cable should be wrapped around the unit and secured in the cable holster (tethered units).
6.	Charging Connection Point (untethered units)	When cable not in use, the charging cable should be unplugged and stored in a cool dry place.
7.	RGB Indicator	Visual Indicator that changes colour dependant on the zappi's charging state. (see RGB Indicator page 9)



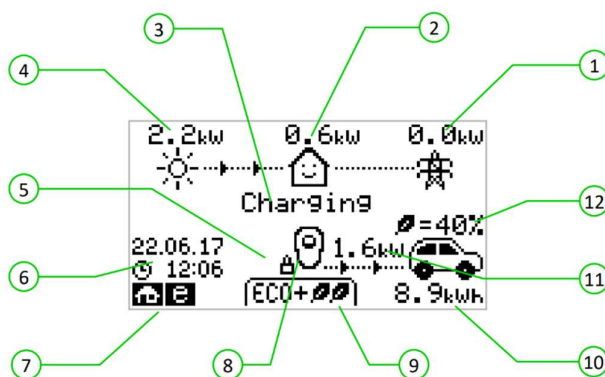

Operation

Display



1. Import / Export Power	The power being either imported or exported from or to the grid (kW). The direction of the arrows indicates if the property is currently importing power (left) or exporting power (right). The size of the arrows is proportionate to the level of power being imported / exported, When the property is neither importing or exporting power the figure will be 0.0kW and there will no animated arrows. The property is then said to be 'in balance'.
2. House Load Power	The power that the property is currently using in kW. (Note: This is displayed only when the Generation Sensor is installed directly to a CT input or a harvi or other myenergi device)
3. Status Text	The current status is displayed here (see Status Screens Page 12).
4. Generation Power	The power being generated at this time in kW. (Note: This is displayed only when the CTs are installed either hard wired to the CT inputs of the zappi or wirelessly to a harvi or other myenergi device)
5. Lock Icon	Operation lock is active.
6. Date & Time	The current date and time.
7. Mode Icons	These icons indicate that the import limiting is active (house), Demand Side Response (~) or the eSense input is live (e) see page 44.
8. zappi Icon	If you see wavy lines above the zappi icon, the unit is thermally limiting! The output power is temporarily reduced.
9. Charge Mode	Shows the selected Charging Mode; FAST, ECO or ECO+ (see Charging Modes page 14).
10. Charge Delivered to EV	The accumulated charge energy that has been sent to EV in this charge session.
11. Current Charging Power	When the EV is charging, arrows will show here along with the charging power in kW.
12. Green Level of Last Charge	This is the percentage of 'Green' energy for the last charge session, this is shown at the end of a charge or when the EV is unplugged.

Display Icons Key

	House Consumption – Not Importing		Charge Mode = FAST
	House Consumption – Importing		Charge Mode = ECO
	Solar Generation Power		Charge Mode = ECO+
	Wind Generation Power		Charge Mode = STOP
			zappi Device – Normal
			On the three phase zappi the number in the icon indicates whether the EV is charging with a single phase or all three phases.
	Grid Power – Import / Export		zappi Device – Too Warm (output limited)
	Power Flow Direction – Small Amount		Import Power Limiting Active
	Power Flow Direction – Medium Amount		Economy Tariff Electricity Available
	Power Flow Direction – Large Amount		Current Charging Power
	Waiting for Surplus Power		Energy sent to EV for this charge
	DSR Mode (demand-side response) ²		Warning – refer to text on screen
	Lock icon – zappi or cable locked (untethered versions only)		

RGB Indicator

The lighting flash indicator on the front of the zappi indicates the status of the charge. The default colours are:

Pink:	Connected
Green:	Charging 100% Green
White:	Charging from Grid only
Yellow:	Charging mix of grid/green energy
Blue:	Charge complete
Red:	Error

These colours can be adjusted on Display & Sound menu (firmware version 2.163 onwards)

The colour effect (pulsing of the LED brightness) varies according to the charging power

² DSR – Demand Side Response – A smart feature for future use by electricity suppliers and distribution companies to help manage load on the electricity system at times of high demand. This feature can only be enabled by the owner of the zappi

Operation

Status Screens

EV Disconnected

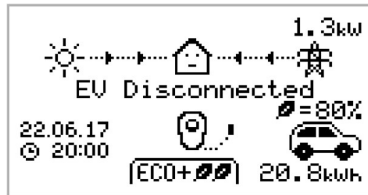

The EV is not connected to zappi.

In this example the last charging session delivered 20.8kWh of energy to the EV and 80% of that energy came from the solar panels.

Waiting for Surplus

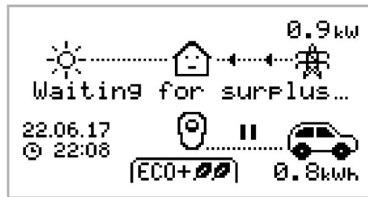

zappi is waiting for sufficient surplus power from the microgeneration system. This screen will be shown in ECO+ mode as it is only in this mode that charging will stop if there is not enough surplus power.

The house in the centre is straight-faced as grid electricity is being used by the house (0.9kW in the example shown).

Surplus

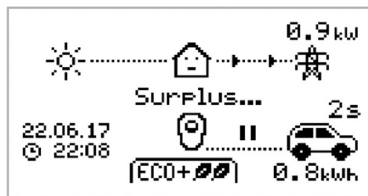

Enough surplus is available and zappi is about to charge the EV. A timer is decremented and can be set in the charge settings (ECO+ mode only).

Waiting for EV...

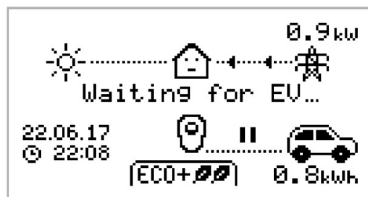

zappi is waiting for the EV to respond; the EV is not ready to accept charge.

Charge Delayed

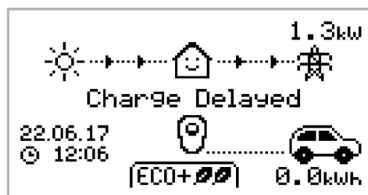

The charging session has been delayed by the EV because a scheduled charge has been set in the vehicle.

Paused...

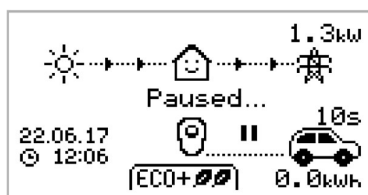

zappi is paused for a few seconds in order to limit the start/stop frequency during ECO+ mode charging.

Charging

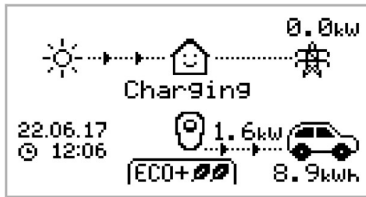

The EV is charging.

In this example the car is charging in ECO+ mode at 1.6kW, there is no import or export from the grid (0.0kW) and the EV battery has charged by 8.9kWh since the car started.

Charge Complete

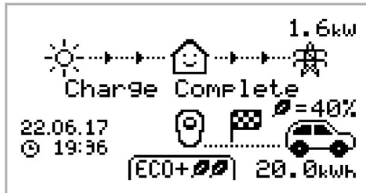

The EV is fully charged.

The charge energy used during the last charge is displayed at the bottom right (20.0kWh in this case) and the 'green contribution' is also shown (40% in this example).

Restart...



zappi is performing a restart sequence.

This may happen with some EVs that need to be 'woken-up' to start charging after a pause in the charge. Charge should start immediately afterwards, otherwise the "Charge Delayed" message will appear.

Stopping...



zappi is about to stop the EV charging

Checking...

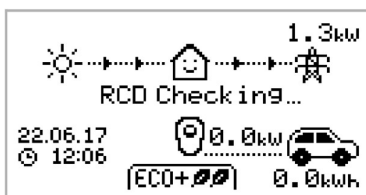

zappi is carrying out a check to make sure that the built in RCD and "PEN Fault" protection is working before starting to charge the car. zappi carries out this before every charge so there is no need to manually test the RCD protection.

Charging Modes



zappi has three different charging modes and a “STOP” mode which can be selected simply by pressing the and buttons when the main screen is showing. The charge mode can be changed before or during a charge.

Regardless of the charge mode, all the surplus electricity is used. zappi's special eco charge modes limit the amount of grid electric used. Below is explanation of each of the charging modes.

Charges at the fastest rate.

Fast Mode will charge the EV at the fastest rate and will import grid electricity if there is insufficient surplus generated power.

The actual charge rate is dependent on the EV's onboard charger and the grid supply voltage. Some vehicles can charge at 11kW or 22kW on a 3-Phase zappi, but many EV's have lower charge rates. The maximum charge rate for the single phase zappi is 7kW.

Adjusts the charge rate to limit the use of electricity.

The charge rate is continuously adjusted, in response to changes in generation or power consumption elsewhere in the home, thereby minimising the use of grid power.

Charging will continue until the vehicle is fully charged, using available surplus power.

If at any time, the available surplus power falls below 1.4kW, the shortfall will be drawn from the grid.

Note: The EV charging standard does not support charging below 1.4kW.

Adjusts the charge rate to limit the use of grid electricity and will pause the charge if there is too much or any grid electricity being used (setup dependent)

The charge rate is continuously adjusted, in response to changes in generation or power consumption elsewhere in the home, thereby minimising the use of grid power. Charging will pause if there is too much imported power, continuing only when there is enough surplus power available. The surplus power threshold at which the charge will start or stop can be set using **Min Green Level** in the **ECO+ Settings** of the **Charge Settings** menu.

The actual green contribution percentage is shown when the charge is complete or when the zappi has been disconnected from the EV.

It is possible to charge the EV using only surplus renewable power, if there is sufficient surplus power available and a boost option has **not** been set. (**Please note:** The EV charging standard does not support charging below 1.4kW)

Example: when zappi is set to a Min Green Level of 100% you will need in excess of around 1.4kW of surplus energy available to start the charge. If the surplus falls below the 1.4kW threshold the charge will pause until the threshold is once again met. After a short delay zappi will resume charge.

If preferable, you can set the zappi to share power from the grid and a generation source to ensure a charge is always maintained. For example, the Min Green Level could be set to 75%. A charge will then start when there is a surplus of 1.05kW, taking a further 0.35kW from the grid. It is worth noting that this is only required to start a charge. If a higher amount of surplus becomes available it will be consumed, resulting in less being drawn from the grid.

STOP The output from zappi is turned off

In STOP mode zappi will not charge your EV. **This includes the boost modes and timed boost.** zappi will continue to measure power and communicate with the other myenergi devices.

Manual Boost

The Manual Boost function can only be used when charging in ECO or ECO+ mode. When boosting, the charge rate is set to maximum (just like FAST mode), until a set amount of energy has been stored in the EV's battery. After which, zappi will revert to ECO or ECO+ mode.

This function is useful if you arrive home with an almost flat battery and would like to charge the vehicle immediately to ensure there is enough charge for a short trip if needed.

The amount of energy delivered to the EV during the boost charge can be changed in the Charge Settings/Boost menu.

When in ECO or ECO+ mode, each press of the button will cycle through the boost options as illustrated below:

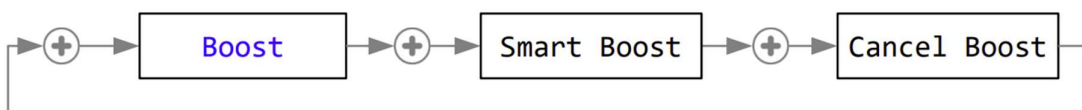

Activating Boost

1. When charging in ECO or ECO+ mode, press **+** until BOOST is shown.
2. The boost will start after a couple of seconds and the display will show the remaining boost energy

The boost duration can be altered in the Charge Settings/Manual Boost menu option.

Cancelling Boost

The boost can be cancelled by pressing **+** until Cancel Boost is shown.

Smart Boost

The Smart Boost function will charge the EV with a minimum kWh figure by a set time. Smart Boost is available only in ECO and ECO+ modes.

- **The Smart Boost function does not bring the battery to a certain state of charge. The target kWh is only the energy added during the charging session.**

When in ECO or ECO+ mode, each press of the button will cycle through the boost options as illustrated below:

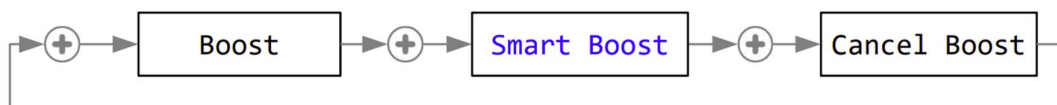

Example: It's a sunny Sunday and you wish to ensure there is enough charge in the EV to get to work in the morning (e.g. 15kWh), but in the meantime, you want to use the surplus energy from the PV system to charge the car, so you choose to use ECO+ mode. At sunset there was only 10kWh of charge accumulated. However, because you activated

Operation

Smart Boost, and set the time you needed to leave for work, zappi automatically boosted the charge in the night to top up the battery to the required 15kWh by 7am.

Activating Smart Boost

1. When charging in ECO or ECO+ mode, press **+** until SMART BOOST is shown.

2. The SMART BOOST icon will show including the target time and the pre-set energy amount.

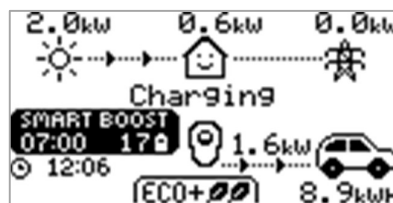

3. zappi will then test the EV for a few seconds, to determine the maximum charge rate.



4. The boost will start at the latest possible time to achieve the set energy amount, if the current charge session has already accumulated enough energy, the boost will not be required and so will not operate.

The required energy and target time can be altered only when Smart Boost is not active. These settings are in the Charge Settings/Smart Boost menu option.

Cancelling Boost

The boost can be cancelled by pressing **+** until Cancel Boost is shown.

Programming the Smart Boost Values













1. From the main screen, press **=** to enter Main Menu
 2. Select Smart Boost from within the Charge Settings menu. The SMART BOOST screen is then shown
 3. The boost can now be edited: Use **▲** or **▼** buttons to edit the target time and amount of charge (kWh) that is required
 4. Use **+** to move to the next value, and the **=** to return to the main screen once the required Smart Boost parameters have been set
-

Boost Timer

When using ECO or ECO+ charge modes, zappi can be programmed to 'boost' the current charge at certain times. When boosting, the charge rate is set to maximum (just like FAST mode), regardless of the amount of available surplus power. This means that power may be drawn from the mains grid supply during boost times.

- There are four editable time slots which can be set to operate for certain days of the week.
- Setting the duration to 0h00 will make the boost inactive.

Programming Boost Times

1. From the main screen, press  to enter Main Menu
2. Select Boost Timer from within the Charge Settings menu. The BOOST TIMER screen is then shown.
3. The boost can now be edited: Use  or  buttons to highlight the time slot you wish to change. The lower screenshot shows the start hour being edited:
4. Alter the start hour with the  or  buttons and then press  to move to minutes.
5. Edit the duration in the same way and then press  again to edit the days of the week you want the boost to be active for. Each day of the week can be toggled on/off with  or  buttons. Press  to go to the next day. Pressing  on the last day (Sunday) will confirm the boost time slot and the whole line will be highlighted again.
6. Press  to exit the BOOST TIMER screen.

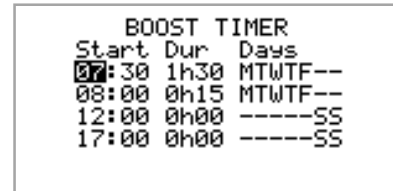

Economy Tariff Boosting

Boosting only when economy rate electricity is available can be achieved in one of three ways:

1. By setting the boost timer to coincide with the economy tariff times. This option should be used only if the electricity meter is a dual-rate meter (modern meters usually are).
2. Boost only at set times AND if economy rate electricity is available.
3. Automatically boost whenever the economy tariff rate electricity is available, regardless of boost times*

*Options 2 and 3 are available only when using the eSense input.

For option 1, the eSense Input in the Advanced menu should be set to Boost Timer Enable.

With the Boost Timer Enable function set, the BOOST TIMER screen will include an extra column. The e can be toggled on/off. If e is present, the boost will activate only when the boost times are valid and the economy rate tariff is available.

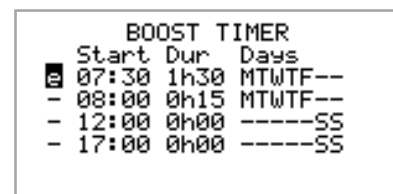

Alternatively the eSense input can be used to activate the boost whenever the economy tariff rate electricity is available, regardless of boost times (option 2). To do this, the eSense Input option in the Advanced menu should be set to Boost. When using this option, the Boost Timer is not needed.

Boost Time Conflicts

If one or more boost times conflict, the boost will follow the latest time or longest duration.

Lock Function

zappi can be locked from unauthorised operation. The Lock Function requires a PIN number to be entered before the unit can be operated and/or a charge is allowed. The main display can also be hidden when zappi is locked.

The lock can be set to be active

- Only when the EV is plugged in
- Only when the EV is unplugged.
- All the time.

The settings for the Lock Function can be found in the Other Settings/Lock Function menu option.

Lock Function Setting	Description
EV Plugged	The Lock Function is active when the EV is plugged in, preventing tampering with the charge session, or changing any settings
EV Unplugged	The Lock Function is active when the EV is disconnected, preventing unauthorised charging
If EV Plugged and EV Unplugged are both set, then the PIN lock is always active. zappi is effectively locked against any unauthorised use and the PIN code will always be required to make any changes locally or to start a charge. These are the recommended settings if zappi is mounted in an exposed / publicly accessible location and you do not want anyone else to be able to use it.	
Timeout	The time before the Lock Function automatically reactivates after being unlocked
Lock Code	This is the current lock code and is five digits from (1 to 4), it can be changed here Default code: 44444
Auto Hide	If set, this will hide the main display of the zappi to keep the power readings private
Charge:	Allow a charge session without the need to enter a pin-code. Useful to leave zappi access free but with the settings protected.
Test	Tests the socket lock solenoid when the charging cable is not plugged in.
If zappi will be used to provide public access for EV charging, then it is recommended to use the following settings: <ul style="list-style-type: none">• EV Plugged - On• EV Unplugged - On• Charge - On• Lock Code - changed to a private PIN number	

Socket Lock

For untethered units only, the EV cable will be locked automatically when it is inserted into the zappi, even if it is not plugged into the EV. A small 'lock' icon will be seen on the right side of the zappi, in the centre of the screen. When the EV is disconnected, a press of the ⊕ button, will unlock the cable for a duration of 5 seconds, allowing the cable to be removed from zappi. After this time, the lock will be re-activated.

If the 'Lock Function' (PIN lock) feature is enabled in the zappi, the cable will not be locked into the socket until the PIN is entered and EV charging starts. This means that if anyone plugs their cable into the zappi but they do not know the PIN they are able to remove their cable.

In all cases the cable is unlocked if zappi detects a fault or the power supply to the zappi is switched off.

Menus

Menus

Main Menu

Main Menu Options		Description	
Charge Log...	Today...	Log of Charge Sessions	
	Yesterday...		
	Week...		
	Month...		
	Year...		
	Total...		
	Custom Date...		
Event Log...	Today...	Log of Events	
	Yesterday...		
	Week...		
	Custom Date...		
	WCS...		
Readings...	Readings 1/9	Status: Mode:	Current status and charging mode of the unit
		Exporting: Importing:	Power being exported or imported, from or to the grid respectively
		Charging:	Power level in Watts being supplied to the EV
		Pilot (PWM):	Control Pilot PWM
		Charge Current: / I(A)	AC current supplied to the EV
		Unit Temp:	Internal temperature of the zappi unit
	Readings 2/9	Voltage:	Supply voltage to the unit
		Voltage Max:	Maximum supply voltage since switch-on
		Voltage Min:	Minimum supply voltage since switch-on
		Frequency:	Grid frequency
		Exporting: Importing:	Power being exported or imported, from or to the grid respectively
		PH1 PH2 PH3	Indicates which phases are active when charging
	Readings 3/9	Exporting: Importing:	Power being exported or imported, from or to the grid respectively
		Generation:	Power from the generator (if available)
		Consumption:	Power consumed by the house (if available)
		Diverted:	Total diverted energy (inc. all mϕenergi devices)
		Charging:	Current power being supplied to the EV
		Charge Energy:	Energy supplied to the EV during current charge session
		Time:	Duration of the current charge session
	Readings 4/9	Exporting: Importing:	Power being exported or imported, from or to the grid respectively

		Battery:	If an AC battery is being monitored the batter power reading is shown: Discharging (+) Charging (-)
		Britain GMT/BST	The set time zone
		LOC:	Local time
		UTC:	Coordinated Universal Time
	Readings 5/9	CP (Control Pilot) related debug information	
	Readings 6/9	DSR related debug information	
	Readings 7/9	Power Readings	Debug screen in preparation for automatic switching between a single phase and three phase charging
	Readings 8/9	Packet Counters	Displays activity over the wireless and Ethernet links
Information...	Information 1/5	Status:	Status of the unit
		Serial No:	Serial number of the unit
		Firmware:	Firmware version installed in the unit
		Assembled:	Factory assembly date
		Cal Date:	Calibration changed date
		Power Fail:	Time and date of last supply failure
	Information 2/5	Grid Sensor:	Grid current sensor source
		Last Fault:	Last recorded fault code
		Fault Date:	Date and time of last recorded fault code
		zappi 1ph Untethered	Identifies the zappi type, e.g. 3 phase or single phases / tethered or untethered. A "!" mark shows a missing phase for 3 phase units
		zappi 1ph Tethered	
	zappi 3ph Untethered		
	zappi 3ph Tethered		
	zappi 3ph!		
	Information 3/5	Network ID:	Network information for this device when linked to other devices using myenergi radio frequency (RF) network (Only shows if connected to other devices)
		Device Address:	
		Master Address:	
		Channel:	
		EUI:	
		MNID:	
EV: Active:		Auto updates on 3 phase zappis following the first charge session to indicate if the EV is capable of charging with 3 phases and whether 1 phase or 3 phase charging is active	
Information 4/5	Time:	Current time	
	Date:	Current date	
	Up Time:	Length of time passed since last switch on	
		Network load control limiting information:	

Menus

		DDL: II: LGA: MGA: DSR:	DDL = Dynamic Device Limit (A) II = Input current (Amps) LGA = Load Group Limit Active (Y/N) MGA = Monitor Group Active (Y/N) DSR = Demand Side Response Active (Watts and time to live) See Load Balancing / Current Limiting (page 52)
	Information 5/5	IP: Mask: Route: DNS: DirIP: Cloud: OFWIP:	Details of Ethernet connection (if zappi has an active Ethernet connection) plus IP addresses of myenergi servers
Linked Devices Info...	Devices PWR Now		Power currently being drawn by the linked devices
	Devices PWR Allott		Available power allotted to the linked devices
	Devices PWR Max		Maximum power that can be used by each device
	Devices PWR Min		Minimum power that can be used by each device
	Devices Misc		Further information about power allocation of linked devices: Total Allotted = Total power allotted to all devices Total Loads = Power consumed by all devices Surplus Power = Unallocated power O/D Power = Total power over-drawn by devices Export Timer = Delay before surplus is allocated

Charge Settings...	ECO+ Settings...	Min Green Level:	ECO+ charge mode settings
		Start/Stop Delay:	
		Plug-in Charge	
	Manual Boost...	Manual Boost settings. See Manual Boost page 15.	
	Smart Boost...	Smart Boost settings. See Smart Boost page 15.	
	Boost Timer...	Programmable boost times. See Boost Timer page 18.	
	Preconditioning...	Configure how zappi respond if the EV starts preconditioning once the previous charge is complete. See Preconditioning Page 32.	
	Default Mode:	Can be set to "FAST / ECO / ECO+ / MEM" (MEM stands for memory, i.e. last set mode before zappi reset)	
ECO/ECO+	Sets the number of phases for ECO & ECO+ charge modes (<i>only available on 3 phase zappi</i>)		
Other Settings...	Time & Date...	Time:	Sets the current time in 24-hour format
		Date:	Sets the date in Format (see below)
		Format:	Sets the format of the date

		Auto DST:	Automatic Daylight-Saving Time adjustment	
		Zone:	Sets the time zone	
		Update from Cloud:	Sets the time automatically. If set to “ON” the time and date cannot be adjusted manually	
	Display & Sound...	Language	Sets the Language for the main screen and menus	
		Icons	Generation:	Generation icon can be set to sun or wind
			Monitoring:	If there is no generation on-site, then generation monitoring can be switched off and the icon will not be shown on the main screen.
		Backlight	Sets the duration that the display backlight remains on after a button press	
		Contrast	Sets the display contrast	
		Set Buzzer	Switches the buzzer ON or OFF for button presses and mode changes	
		RGB LED	TEST	Test function to customize LED on front cover
			Brightness	Sets the brightness of the LED
			Colours	Customize your own LED colours
	Lock Function...	EV plugged:	Lock is active only when EV is plugged in	
		EV unplugged:	Lock is active only when EV is unplugged	
		Timeout:	Length of time for the lock to reactivate after unlocking	
		Lock Code:	The lock code can be changed here (Default is 44444)	
		Auto Hide:	Hide the main screen when zappi is locked	
		Charge:	Allows charge sessions without unlocking zappi with the pin code	
		Test:	Test the lock solenoid when NO cable inserted	
	Advanced...	Advanced menu and settings (passcode protected) Default passcode: 0000		

Advanced Menu

Advanced Menu Options	Description		
Supply Grid...	Device...	Phase: (single phase)	Sets the supply phase to use for this device – see Advanced Settings (page 28) for more information
		Phase Rotation: (three phase)	
		Phase Return:	Sets the phase wired into the "Neutral" input terminal (Used where zappi is installed on a 230V “delta connected” supply – the Phase Return will normally be set to Neutral)
		Device Limit:	Sets the maximum available supply current to be drawn by the zappi – see Advanced Settings page 2528 for more information
		Neutral Limit:	Sets the maximum neutral current for the installation. Needed in some countries with specific regulations (e.g. Germany)
	Earthing:	Enable or disable the PE conductor checks. To be set according to the earthing arrangement in the installation (TN/TT or IT)	
	Network...	Export Margin:	Minimum level of export power which is maintained when zappi is diverting surplus power – see Advanced Settings page 28 for more information
		Grid Limit:	Maximum grid import power limit. When charging, the charge power is reduced to keep import below this level. This also applies when boosting – see Advanced Settings Page 28 for more information
		Battery:	Sets the mode for managing power when an AC battery system is present in the installation. See Battery Storage Systems (page 52) for more information.
		Net Phases:	Allows surplus power from one phase to be used on a different phase when multiple phases are in use. – see Advanced Settings (page 2825) for more information.
Note: The Network menu options only appear and can be configured on the MASTER device			
Linked Devices...	Devices...	Other myenergi devices can be wirelessly linked, this shows connected devices and their priorities. Settings for some devices are made here – see <i>Linking Devices</i> (page 3431)	
	Pairing Mode...	Puts this zappi in pairing mode so it can be linked to another device – see <i>Linking Devices</i> (page 3431)	
	Channel...	RF Channel:	Sets the radio frequency channel number used when linking other devices – see <i>Linking Devices</i> (page 33)
	Set Master...	Sets the zappi device to be master (✓ is shown) or slave – see <i>Linking Devices</i> (Page 33)	
	Reset Settings...	Clear all linked device settings – see <i>Linking Devices</i> (Page 33)	

CT Config...	CTINT:	Internal CT, used to configure a group limit. See Load Balancing / Current Limiting (page 51) for details.	
	CT1: CT2: CT3:	Set the function of CT inputs – see CT Config (page 29) for more details.	
eSense Input...	Disabled	eSense input is disabled	
	Boost	If the eSense input is live, zappi will boost the charge – see eSense (page 29)	
	Boost Enable	Timer	zappi will boost the charge if eSense is live AND the boost timer is set to operate at that time - see eSense (page 29)
	Load Limit	If the eSense input is live, zappi will limit the charge rate to the set amount. The default current limit is 7.2A but can be set as desired – see eSense (page 33)	
	Stop	If the eSense input is live, zappi will stop the charge regardless of its charge mode - see eSense (page 33)	
Compatibility Mode...	Active:	When set to “On” the zappi will adapt to EV's with poor power factor	
	Min PWM:	Controls the Pilot PWM minimum limit	
	Power Factor:	When Active is “On” the charging current set point from zappi to the EV will not go below the Min PWM value unless the measured power factor is better than this set value.	
	End Charge Delay:	Charge Complete status is delayed by this time to allow access to the vehicle without starting a new charge session	
Menu Passcode...	The code required to access the Advanced Menu		
System...	Restore Settings...	Erase Config	Restore the configuration to factory default
		Erase Data	Clear all data from memory (charge logs, event logs & historic data)
		Erase ALL	Restore configuration to factory default and erase all data
		Confirm	Confirm restore options and re-boot device
	Download Firmware...	Download latest firmware (See separate vHub manual for further information).	
	Bootloader...	Enter Bootloader mode	

For the built-in hub functionality (vHub), details on how to connect your zappi to the internet and the menus for the built in WiFi please see the separate vHub manual.

Configuration

Configuration Settings

All settings are described in the *Main Menu* section; however, the more commonly altered settings are described in more detail below.

Time & Date

The date and time are used for the Boost Timer and the savings calculations and therefore should be set correctly. In the event of a power-cut, and providing the zappi has a connection to the internet the zappi will update the time and date automatically once the power is restored.

Even if the zappi does not have an Internet connection its internal clock will continue keep track of the date / time for approx. 24 hours.

Time is always in 24-hour format, but the date format can be changed.

zappi will automatically adjust the clock for Daylight Savings Time (DST) as long as Auto DST is enabled, and the correct time zone is selected.

The following Time and Date settings are recommended:

- Timezone – set to correct timezone
- Auto DST – On
- Update from Cloud - On

Display & Sound

The Generation Icon on the zappi display can be changed to match your local system.

Select between “Sun” (PV) and “Wind” on the Icons... submenu to change the icon

If do not have any local generation then the icon can be turned off by changing the Monitoring... setting

RGB LED

zappi has a coloured LED light on the front which changes colour and flashes to provide a visible indication of the charge state. The brightness of the LED and the colours can be adjusted from the RGB LED menu.

Grid Limit

When the Grid Limit is set, zappi will automatically reduce the power going to the EV if it detects that too much power is being drawn from the grid.

CT Detect (“G100”)

“G100” is a UK standard which some distribution companies use when setting the requirements for the Grid Limit (or “load curtailment”) function in EV charging equipment. One requirement is that the equipment should detect if the grid CT is disconnected.

When the CT Detect Protection setting is turned on (default) zappi will detect that the grid CT has become disconnected and will limit the output from the zappi to prevent the grid supply being overloaded.

This setting applies to wired CT’s and is found on the Advanced – CT Config menu .

Advanced Settings

The Advanced Settings menu is passcode protected.

The default passcode is 0 0 0 0 although it can be changed with the Passcode menu option.

Supply Grid – Device Settings

Phase/Phase Rotation

Single Phase zappi	<p>The Phase setting is only used when installing a single phase zappi onto a 3-phase supply.</p> <p>It should be set to match the phase number that the zappi is wired to so that the power measurements are correct and that the zappi responds to the correct phase when using the harvi wireless sensor.</p>
Three Phase zappi	<p>The Phase Rotation setting is only used on three phase units and should correspond to the wiring to the input terminals. Only the following specific options are available:</p> <ul style="list-style-type: none">• 1/2/3 (Phase 1 wired into “L1”, Phase 2 wired into “L2”, Phase 3 wired into “L3”)• 2/3/1 (Phase 2 wired into “L1”, Phase 3 wired into “L2”, Phase 1 wired into “L3”)• 3/1/2 (Phase 3 wired into “L1”, Phase 1 wired into “L2”, Phase 2 wired into “L3”)

See *Three-Phase Systems (page 51)* and *Net Phases (page 28)* for more information.

Phase Return

Single Phase zappi only

When a single phase zappi is installed on a 230V delta connected supply, it is necessary to tell zappi which phase has been connected to the neutral terminal.

Note: *In most installations the Phase Return setting should be left as “N” for Neutral*

Device Limit

Sets the maximum current that the zappi will draw (including when boosting and FAST mode). This is useful if the supply current is limited, for instance, if zappi is connected on a 16A circuit instead of a 32A.

Neutral Limit

In some countries the electricity distribution company limit the maximum current that can flow in the neutral conductor on a three phase supply (for example, the neutral current is limited to 20A in Germany). Use this setting if a neutral current limit is specified for your installation.

Earthing

Before starting a charge, zappi carries out a check to make sure that the protective earth conductor is still connected. This check only works in a TN or TT connected electricity supply. If you are on an IT supply or find that the protective earth check is too sensitive then change this setting to “IT”.

Supply Grid – Network Settings

Grid Limit/Load Curtailment

Sets the limit that can be drawn from the grid connection (i.e. the maximum import current or the main fuse rating).

Example: A property may have a grid supply limit of 65A. Several appliances are on so the property is consuming 12kW (52A). The user wants to charge in FAST mode. Without the Grid Limit set, the total consumption would exceed the allowed import current and trip the supply or blow a fuse. However, with a Grid Limit setting of 60A, zappi would temporarily limit the charging current to 8A (about 1.8kW) and the maximum allowed import current would not be exceeded.

Note: When using a *harvi* to measure the grid supply, the highest value for the Grid Limit setting is 65 Amps. The maximum current limit when using a hardwired CT is 100A

Note: For installation in the UK where the Distribution Network Operator accepts load curtailment instead of an upgrade to the supply, the Grid CT must be wired to the *zappi* and cannot be used with a *harvi*.

Battery

If the property has a static AC battery system installed, it is possible to get the *zappi* to work in harmony with the battery system, provided a CT has been installed to monitor the battery inverter. See Battery Storage Systems (page 52) for more information about battery storage systems.

The table below details the different settings for working with an AC coupled battery storage system:

Setting	Function Description
None	There is no battery system installed.
Avoid Drain	Stops the <i>zappi</i> (or other linked <i>myenergi</i> devices) draining the battery when using surplus power from the solar or wind generation.
Avoid Charge	Effectively allows the <i>zappi</i> (or other linked <i>myenergi</i> devices) to take priority over the battery when charging from solar or wind generation.
Avoid Both	Provides both of the above functions. This setting will normally provide the best compatibility
Limit to Gen	Will limit the output of the <i>zappi</i> (except when boosting), to prevent unwanted draining of an AC coupled battery system. This setting does not require a CT to monitor the battery but does need a CT to monitor the solar/wind generation. Note: This setting is to support legacy installations – it is preferable to install a CT to monitor the battery and use one of the settings below.

Net Phases

When enabled, all readings from 3-phase *myenergi* devices configured as 3-phase, will be netted. This means that surplus generation on ANY phase will be considered available for consumption on ANY other phase.

See Three-Phase Systems (page 5147) for more details about *myenergi* devices on 3-phase supplies.

Note: With a three phase *zappi*, Net Phases should normally be turned on

Export Margin

This sets a minimum level of export power which is maintained when zappi is charging in ECO or ECO+ modes.

Export Margin would normally be set to 0W (zero Watts) so that all available surplus will be used to charge the vehicle. In some cases, it may be desirable to always set a minimum export level set. An instance of this would be when using zappi with a hybrid PV/battery system.

CT Config

zappi measures current by using a number of Current Transformers (CTs). It is important that these are set up correctly so zappi knows the different power flows and can control the EV charge rate.

The 3 CT inputs should be configured to match the connected CT sensors. There are further settings for the internal CT which measures the current being drawn by the EV.

Note: If you have CTs connected to a harvi then these CTs also need to be set up correctly. For a harvi, the CT settings are found through the Linked Devices menu rather than the CT Config menu.

Important: There must be only one Grid CT set (per phase) for the whole installation.

Note: CT3 is only available on single phase units with V3.XXX firmware.

CT	Function Description
CTINT	This is the internal CT which measures the output (charging) current of the zappi
CT1	CT1 Input
CT2	CT2 Input
CT3	CT3 Input

CT Types

CT Type	Function Description
None	No CT connected.
Grid	Grid CT monitors the import and export power of the property. This is the CT used to determine if surplus power is available. There must only be one Grid CT set for each phase
Generation Only	Monitors Solar PV or Wind generation
Storage Only	Monitors a device that can 'store' energy (e.g. a third-party energy diverter) and enables the zappi to take priority over it. The power used by the third-party device is considered as surplus power unless the device is intentionally using grid power (i.e. it is boosting). The CT should be installed on the "live" supply cable feeding the diverter, with the arrow pointing away from it (i.e. towards the consumer unit / fuse board)
Gen & Battery	Monitors Solar PV or Wind generation that is combined with a DC-coupled battery

Configuration

Monitor	Monitors any load, for example a washing machine or a lighting circuit. This setting can also be used to limit current drawn by myenergi devices on a particular circuit which includes other loads. See <i>Load Balancing / Current Limiting</i> (page 51) for more details.
AC Battery	Used to monitor an AC-coupled battery. With this setting it is possible to manage the distribution of surplus energy between the battery and the zappi (and other myenergi devices). The Battery setting in the Supply Grid menu is used to configure how the zappi will operate alongside the battery system. See <i>Battery Storage Systems</i> (page 5248) for more information. The CT should be installed on the “live” supply cable of the battery inverter/charger, with the arrow pointing away from it (i.e. towards the consumer unit / fuse board).

CT Detect Protection

When using a wired CT for the Grid current reading, zappi can also monitor the CT to make sure that it is still connected. This is important when using the Grid Limit (or “Load Curtailment”) function in the zappi and is a required by some distribution companies.

“G100” is a UK requirement which describes the technical requirements for export limiting schemes³. It does not apply directly to “import limitation” or “load curtailment” schemes but the general requirements are referred to by UK Distribution Network Operators in this context.

Normally the CT Detect setting should be turned ON for wired Grid CTs

CT Groups

CTs can be put in groups so that their readings are netted (combined). For example, you might want to monitor two solar PV systems and see the total generation on the display. Use Group in the CT Config menu to set which group the CT should be in.

Note: Different CT Types cannot be in the same group, the group names make this clear.

Only the first 4 groups can be used for current limiting, see *Group Limits* below.

Group Limits

Current limits can be set for certain CT Groups. When a Group Limit is set the myenergi devices in the group will limit the power they draw to keep within the set limit.

Group limits should be set only on the master device. See *Linking Devices* (page 3531) for details about master devices.

It is possible to use more than one group limit type (e.g. IL1 with MN1, so that there are two conditions for limiting). Some examples of how to set up the group limits are described in the table below.

Group Limit Example	Additional CT Installed	CT Config (all devices)
---------------------	-------------------------	-------------------------

³ [https://www.energynetworks.org/assets/images/Resource%20library/ENA_EREC_G100_Issue_1_Amendment_2_\(2018\).pdf](https://www.energynetworks.org/assets/images/Resource%20library/ENA_EREC_G100_Issue_1_Amendment_2_(2018).pdf)

Limit current drawn by two zappi devices that are on the same 32A supply.	None; only the internal CTs are used.	CTINT Type: Internal Group: IL1 Group Limit: 32A
Limit current drawn by a zappi device that is fed from a 32A supply which is also feeding another appliance (e.g. a tumble dryer).	One CT is clipped around Live of the 32A supply and wired to CT2 of the zappi.	CT2 Type: Monitor ⁴ Group: MN1 Group Limit: 32A
Limit current drawn by two zappi devices that are in a garage which is fed from a 40A supply. A washing machine and dryer are also in the garage.	One CT is clipped around Live of the 40A supply to the garage and wired to CT2 of one of the zappi units. Note: The other zappi does not need to have a CT connected, but it will still need to have a CT input configured to be in the same Monitor group.	CT2 Type: Monitor ⁴ Group: MN1 Group Limit: 40A

Preconditioning

Most EV's provide a preconditioning function that can be used to prepare the vehicle for a journey – typically by warming/cooling the inside of the car, defrosting the windscreen and possibly warming the battery so that it is in the optimum state for driving the vehicle.

To avoid draining the battery to precondition the car, the zappi preconditioning mode can be set so that the power needed is provided from the electricity supply.

Note: This feature only works if zappi has detected “Charge Complete” i.e. the previous charge was stopped by the EV because the battery was full.

If this is not the case, then the only way to ensure that the battery is not drained during the EV preconditioning is to set a Scheduled Boost to coincide with time when the EV will be preconditioning.

Setting Preconditioning

The preconditioning mode can set to “On” or “Off”:

CT Type	Function Description
Off	Once zappi detects “Charge Complete”, the next time the EV tries to draw power zappi will revert to the mode set (ie ECO, ECO+ or FAST). If zappi is in ECO+ and there is not enough surplus generation then the charge will pause and zappi will display "Waiting for surplus"
On	When preconditioning is turned ON, the amount of energy (kWh) zappi should supply to warm up the battery / precondition the EV can also be set. Once zappi detects “Charge Complete”, the next time the EV tries to draw power zappi will start a Preconditioning Boost (to the kWh target set) and then revert to normal charging, in whatever mode it is set to.

⁴ **Note:** the “Monitor” group is not currently supported by the harvi

Configuration

Note: Some vehicles (for example the Tesla Model S) need a lot of power to warm a cold battery even for standard charging. If you try to charge one of these vehicles in ECO and ECO+ mode the EV may charge for a short period, stop because it does not have enough power to warm the battery and then immediately try to charge the EV again.

We cannot guarantee that the Preconditioning Mode will cope with this situation but provided the EV draws a small amount of power the first time it tries to charge this should trigger the Preconditioning Mode, providing enough boost power to warm the EV's battery and allow normal ECO/ECO+ charging to proceed.

eSense

The eSense input can be used for two function:

1. It can be configured to automatically activate a Boost during ECO or ECO+ charging, whenever economy tariff electricity is available. The eSense input must be wired to a circuit which is live or an external volt free contact which closes during the economy tariff times for this to function.
2. It can be used to limit the zappi output or stop the charge – for instance, using an external contact from a smart meter or control box provided by the Distribution Company who may require the ability to control the power being used to charge an EV if their network is overloaded

See eSense Input page 43 for wiring details

eSense Setting	Description
Disabled	eSense input is ignored
Boost	If the eSense input is live, zappi will boost the charge
Boost Timer Enable	zappi will boost the charge if eSense is live AND the boost timer is set to operate at that time. See Economy Tariff Boosting (page 17)
Load Limit	If the eSense input is live, zappi will limit the charge rate. The default limit is set to 7.2A but can be altered
Stop	If the eSense input is live, zappi will not charge, regardless of set charge mode or a boost

Linking Devices

Up to six myenergi devices can be wirelessly linked together. By linking devices, you can use more of your own energy or have more control and visibility. Devices available now are:

- eddi A microgeneration energy diverter that uses surplus power to heat water or rooms rather than exporting to the grid.
- zappi An eco-smart electric vehicle charge point that can use surplus power to charge the car.
- harvi A self-powered wireless sensor that can be used along with myenergi load controlling devices such as eddi and zappi. It is able to detect grid import/export conditions as well as generation power and send this information wirelessly to devices such as the eddi or zappi. Using a harvi can greatly simplify installation.

The myenergi devices can be linked using either the built in radio or with an Ethernet cable⁵. If using an Ethernet connection zappi simply needs to be connected to your local network – either with an Ethernet cable running directly to your internet router or via a power line carrier extender.

⁵**Note:** The built in Ethernet port is not available on older versions of the zappi and eddi. This feature is under development and may require a firmware update before the wired Ethernet connection is enabled.

Master & Slave Devices

When two or more myenergi devices are wirelessly linked, one device will act as the *master* device. This device will control the other *slave* devices. Some settings can only be changed on the master device, e.g. Grid Limit and Net Phases.

Use the Set Master function in the Advanced Settings/Linked Devices menu to set which device should be *master*. It's a good idea to choose the device that is the most convenient to access should you wish to change settings.

- **Note:** harvi will only pair with the device which is set as the master
- It is recommended that, where the Grid CT is directly connected to the zappi, that this device is chosen as the master. This ensures the fastest response to the grid power measurement

For further information on master & slave devices, pairing devices and enabling the vHub see separate vHub manual.

Channels

On rare occasions it is possible that there are other appliances operating on the same frequency which could cause interference. If it is not possible to link devices or the connection seems poor, changing the RF Channel may help.

The channel can be changed on devices without having to re-pair them, just makes sure they are all set to the same channel.

Removing Devices

A device can be removed by selecting it from the Advanced Settings/Linked Devices/Device menu and then selecting Remove Device. If you want to remove all devices then use the Advanced Settings/Linked Devices/Reset Settings menu option.

Device Settings

Most device types have settings which can only be changed via the Linked Devices menu. For example, eddi and zappi have a setting for priority and harvi has settings to configure its CT inputs (see Device Priorities page 34).

The device settings are accessed through the Linked Devices menu; select Devices then select the appropriate device and press \oplus to bring up the device settings screen. Refer to the relevant device instruction document for more information regarding the actual device settings.

Note: After a device has been paired you will have to wait a few seconds for the device to update before the settings can be accessed. The screen will show DEVICES UPDATING when this is happening.

Device Priorities

Each myenergi device that controls a load can be given a priority. The highest priority device will be allocated surplus generation power first. Devices can also be set up to share surplus power equally.

The priority of each load controlling linked device, can be set from any device with a display. The example below shows one eddi device, two zappi devices and one harvi on the same 'network'.

The screenshot shows a terminal-style interface with the title "DEVICES". It lists four devices with their IDs, names, and priority values. Callouts 1-5 point to the following elements:

- 1: Points to the first row (eddi...)
- 2: Points to the priority value '70' for eddi...
- 3: Points to the second row (ZAPPI...)
- 4: Points to the priority value '21' for ZAPPI...
- 5: Points to the priority value '246' for harvi...

ID	Device Name	Priority	Symbol
1	eddi...	12345670	∞
2	ZAPPI...	87654321	
2	zappi...	76543210	
	harvi...	24680246	?

1. All linked devices are listed in the DEVICES screen, the device shown in CAPITAL letters is the device currently being viewed.
2. The serial number of each device is shown on the right
3. The priority is shown on the left of each load controlling device with 1 being the highest priority. If two or more devices have equal priority, the available surplus (for that priority level) is shared between them.
4. The ~ symbol indicates which device has the grid CT attached/configured to it. There should only be one in the system.
5. If the ? symbol is shown alongside a device, it indicates that communication has been lost from the device (the device cannot be 'heard').

Linked Devices Information

The current status of all linked devices can be viewed together in the LINKED DEVICES INFO screen which can be found from the Main Menu.

Priority	Device Name	Real-time Output Power	Status
1	eddi	3070W	~
2	ZAPPI	4321W	⌘
2	zappi	1320W	⌘
3	eddi	170W	×
	hub		?

1. All linked devices are shown on the left. The current device is shown in CAPITAL letters.
2. The right side shows each device's real-time output power level.
3. The priority setting for each device is shown on the far left.
4. The far-right side of the screen shows the status of each device. The symbols used are explained below:

- ~ Grid CT - the device has a Grid CT configured (there should only be one)
 - M Master - the device is the controlling device in the network
 - ⌘ Boost - the device is currently boosting
 - ⌘ Max - the device is at maximum output power
 - ⌘ Min - the device is at minimum controllable output power
 - ×
 - ?
- No Load - the device is not able to use surplus power as there is no load
- Communication problem - there is no response from the device

Configuration

Wireless Connection

mϋenergi devices use an 868MHz / 915Mhz wireless link to communicate with each other. Although this is usually more effective at passing through walls than a standard WiFi signal, radio communication can be affected by many factors such as:

- the distance between the devices
- the thickness of any walls that the signal has to pass through
- wall construction and insulation materials
- large metal objects such as washing machines, fridges, sinks and baths
- mirrors
- electronic products such as televisions
- other wireless devices operating on the same radio frequency

Please consider the position of your mϋenergi devices carefully to ensure that they operate as planned.

Although the devices work in the majority of installations and our technical support team are available to provide help in setting up your system, we cannot guarantee the performance where circumstances beyond our control affect the performance of the wireless link.

If you have any concerns about the wireless performance then we would be pleased to answer your questions, but please consider that if a WiFi signal works OK then there is a very high probability that the mϋenergi devices will also work without any issues.

If a wireless connection is not possible, the latest version of zoppi has a built in Ethernet connection. This can be used to link mϋenergi devices that have an Ethernet port simply by plugging an Ethernet cable from zoppi into your local network⁶.

⁶ **Note:** The built in Ethernet port is not available on older versions of the zoppi and eddi. This feature is under development and may require a firmware update before the wired Ethernet connection is enabled.

Ethernet Connection

Zappi's with the built in vHub (identified by the product code ZAPPI-2Hxxxx) are supplied with a built in Ethernet port (RJ45 socket)⁷ and WiFi to connect zappi to the local network (LAN).

This Ethernet connection can be used as an alternative to connecting the myenergi devices using the wireless link. This version of the zappi can also act as the “gateway” or “hub” between all your myenergi devices and the myenergi server⁸.

Note: harvi *can only be connected using a wireless link to the Master device*

When pairing devices, they will automatically use the Ethernet link if available.⁹

Two example setups are shown below

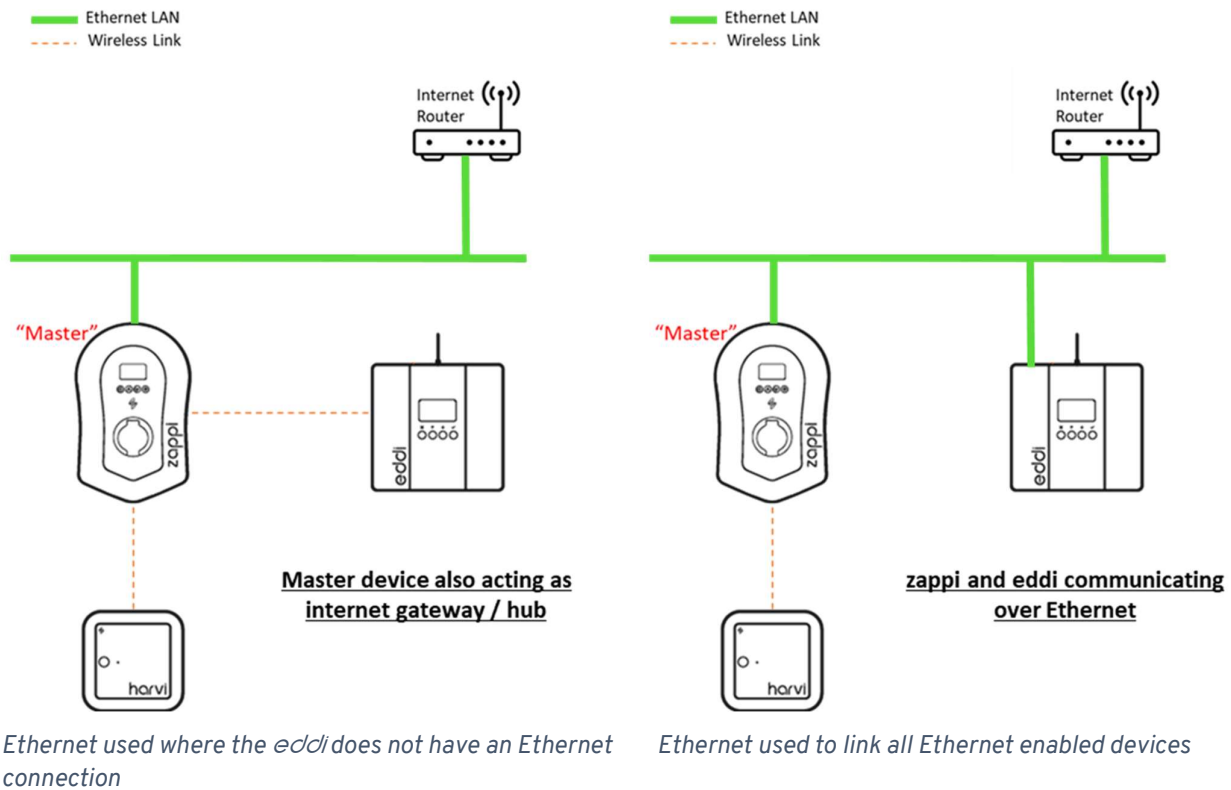

Further detail on the ethernet connection, WiFi and for further configurations see the separate vHUB manual.

⁷ An Ethernet expansion board is available for earlier versions of zappi.

⁸ Earlier versions of the zappi did not have this built in gateway/hub capability. For these devices a separate hub is required to provide the link between the local devices and the myenergi server.

⁹ **Note:** The built in Ethernet port is not available on older versions of the zappi and eddi. This feature is under development and may require a firmware update before the wired Ethernet connection is enabled.

Installation

Installation

- When installing and wiring the zappi, care should be taken to maintain the IP rating of the unit.
- Ensure that the grommets and bungs provided are fitted, the O-ring behind the cover is seated correctly and that the incoming power and CT cables are fitted using an appropriate size and type of gland.

1



Carefully remove fascia from the zappi by pressing the 2 clips located at the bottom of unit inwards whilst pulling the fascia towards you.

2

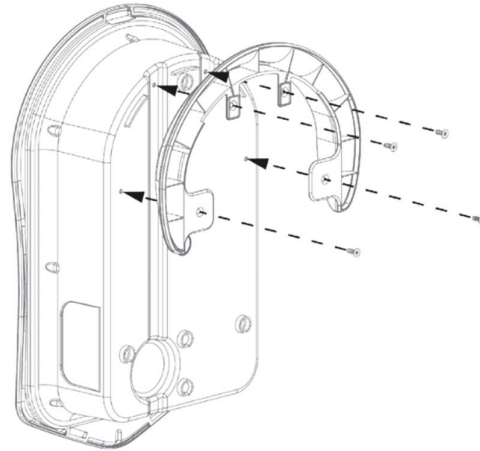

If installing a tethered zappi, you must ensure the cable wall guard is fixed to the unit using the 4 screws supplied.

If installing an untethered zappi go to next step.

3

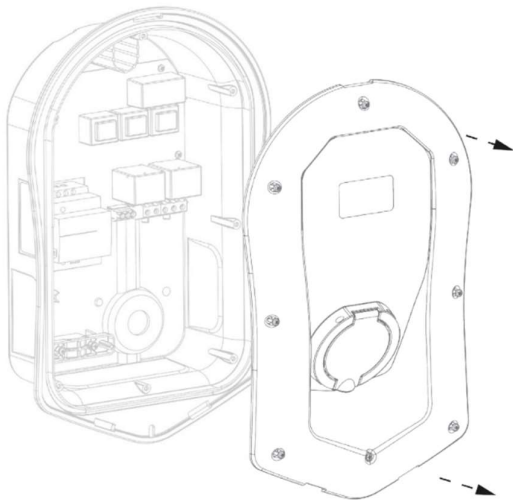

Remove all 8 screws from the enclosure and carefully lift away.

4

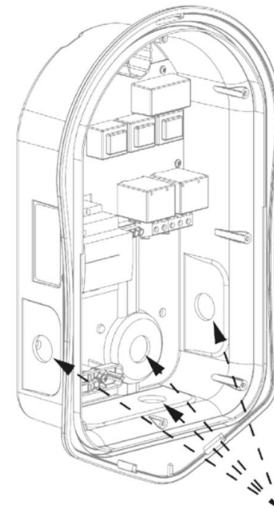

There are 4 possible cable entry positions, carefully decide which one you are going to use from the above image.

You will need an IP65 or above rated cable gland.

Carefully drill a hole into the unit to match the size of your cable gland. Attach cable gland ensuring IP rating is met.

5

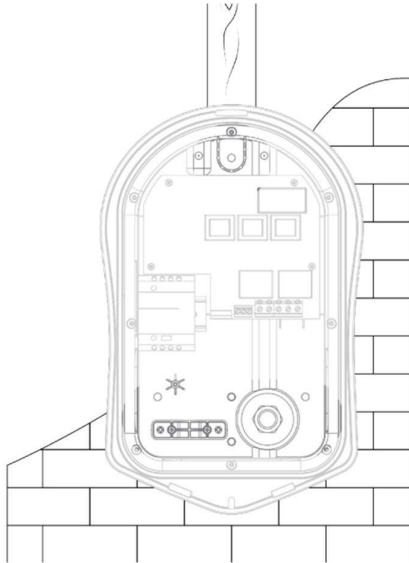

Using zappi template mark mounting holes. For fixing to brick, use the top and 2 bottom holes (left/right). Use the 2 vertical holes as well as the top hole if mounting to a stud wall or joist.

6

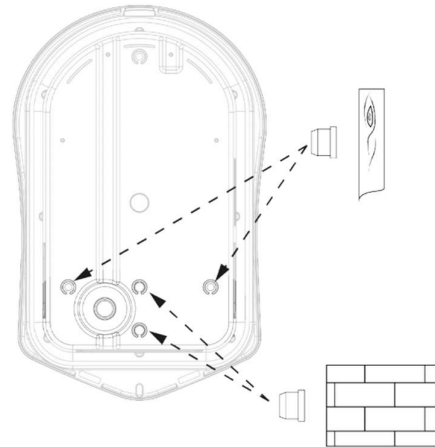

To maintain the IP rating of the unit you will need to add bungs (provided) to the unused holes.

7

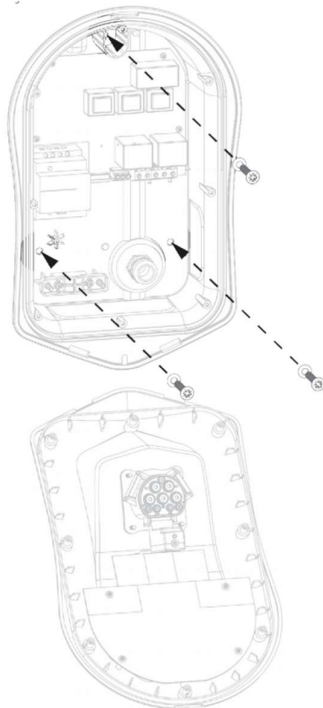

Secure the unit to the wall using the fixing kit provided. Ensure the grommets are used to maintain its IP integrity.

Note: if using the rear cable entry, remember to insert the mains cable before mounting to the wall!

8

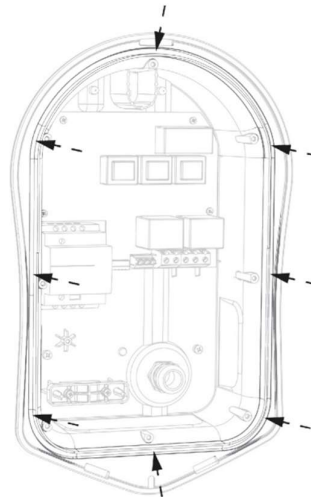

Ensure O-ring is present and sits neatly into its channel.

Electrical Installation

Warnings

- **WARNING!** An electric shock can be fatal; electrical connection work may only be carried out by a competent person
- The earth conductor must be correctly installed and reliably connected
- This device must be equipped with an over-current protection device of maximum 32 Amps (B32)

Supply

The single phase zappi should be connected to a 230V/240V nominal AC supply. The supply should run from a dedicated 32A circuit breaker.

The 3 phase zappi should be connected to a 400V, 4 wire, 3 phase supply. The supply should run from a dedicated 3 pole 32A circuit breaker.

We recommend the use of curve B circuit breakers.

The zappi features an integral 30mA Type-A RCD with 6mA DC leakage detection in accordance with IEC 62955. Local wiring regulations should be consulted to confirm whether an additional upstream RCD is also required.

Earthing

The zappi unit must be earthed in accordance with local regulations.

When installed on a PME (TNC-S) electrical system it is necessary to protect the consumer from a potential electric shock that could occur if the combined Neutral and Earth (PEN) conductor on the supply becomes damaged or disconnected.

zappi includes an additional automatic disconnection device which satisfies the requirements of BS7671:2018 Amendment 1:2020 722.411.4.1 (v) (the 18th Edition IET Wiring Regulations).

This protection device

- a) monitors the supply to identify if there is a problem with the PEN conductor and
- b) disconnects the supply if a situation arises where the end user might suffer an electric shock

This means that the zappi can be installed without the need for an additional earth rod.

However, if the customer or local regulations require that an earth rod is installed (for instance as part of a TT earthed system) then this should be connected to the dedicated terminal on the main circuit board using a ring terminal (as shown below).

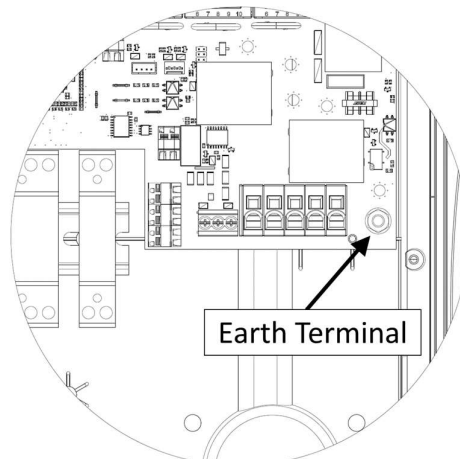

Wiring

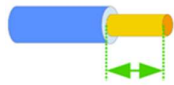

18mm

The main terminals are designed to work with wires with a diameter up to 16mm²

Insert the mains cable through the installed cable gland (if not already done so). Strip back outer sheath ensuring all cables reach the terminal blocks (leaving a little excess). Strip back all coloured cables approx. 18mm.

If using hard wired CT clamps now is the time to insert these too (we recommend a specialist cable gland that can accommodate multiple cables whilst still maintaining IP integrity, or two separate cable glands to ensure zappi remains sealed).

To insert the wires into the terminal blocks a suitable sized screwdriver should be inserted into the slot. This opens the spring terminal allowing the wire to be gently pushed into the terminal. Make sure that the wire is pushed fully home and then remove screwdriver, checking that the wire is secure in the terminal.

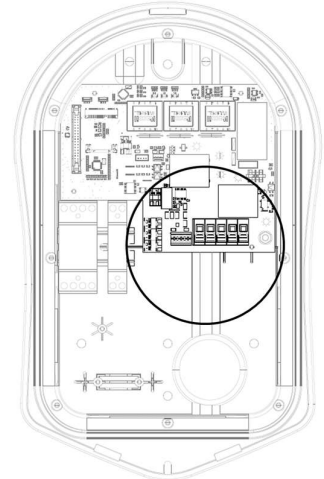

Single Phase Wiring

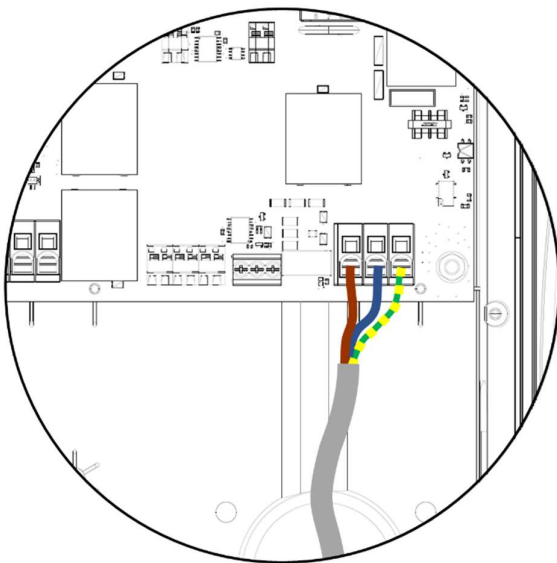

For single-phase installations, without the need for hardwiring an external CT, please follow the above diagram

Earth = Green / Yellow cable

Neutral = Blue cable

Live (L1) = Brown cable

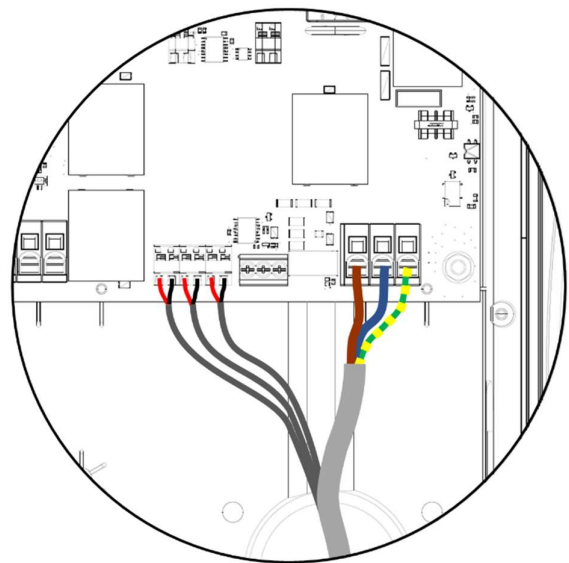

For single phase installations, where 1 or more external/additional CTs are required, please follow the above diagram to connect the CTs. Use the extra CT terminals in the same way if required.

Positive (+) = Red

Negative (-) = Black

For more details on CT installation and connection see CT Sensor Installation (page 47)

Installation

Three Phase Wiring

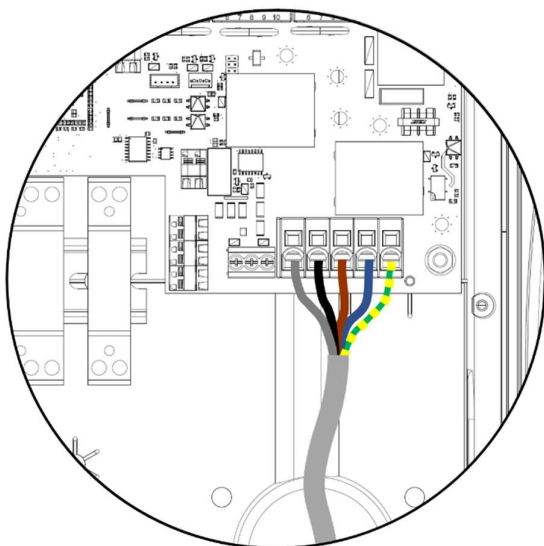

For 3 phase installations, without the need for hardwiring an external CT, please use the above diagram.

Earth = Green / Yellow cable

Neutral = Blue cable

Live (L1) = Brown

Live (L2) = Black

Live (L3) = Grey

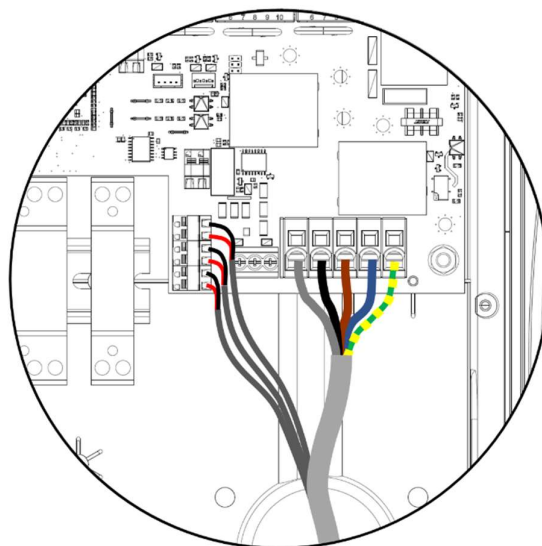

For 3 phase installations, with the need for 1 or more external/additional CTs, please use the above diagram.

Positive (+) = Red

Negative (-) = Black

For more details on CT installation and connection see *CT Sensor Installation* (Page 47)

eSense Input

zappi has an “external Sense” or “eSense” input which can be used with an external input (such as a relay contact or voltage) to

- sense the availability of economy tariff electricity, this can be used to automatically boost the charge when in ECO or ECO+ charging modes.
- force zappi to limit the output or stop the EV charging

IMPORTANT

The connection to the eSense input will depend on the version of the zappi.

Serial numbers starting 1xxxxxxx

The eSense input to the zappi is designed to work with an AC voltage between 100V and 260V.

Serial numbers from 2xxxxxxx onwards

A “universal” Sense input is provided. This will work with an external voltage 24-230V AC/DC wired to the terminals marked “24-230V AC/DC in”

To use the eSense input with a simple “dry” relay contact, a 24V DC supply is provided. The external volt-free relay contact should be wired between the terminals marked “24V out” and “in”

The eSense input is electrically isolated and effectively draws no current so the eSense signal may be connected using a wire with a small cross section.

When the eSense input is active the cause the eSense symbol  will be shown on the main screen.

There is no need to connect the eSense input if you do not want to use this feature.

See eSense on page 3331 for details of how to configure the eSense input

 The following diagrams refer to zappi’s with serial numbers 2xxxxxxx onwards.

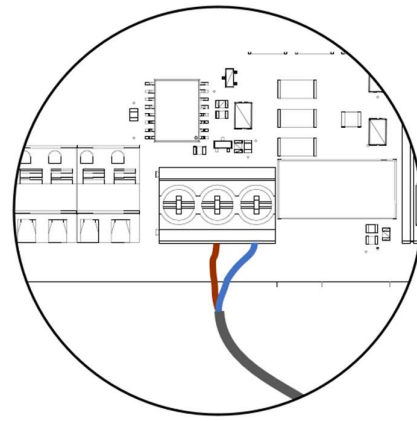
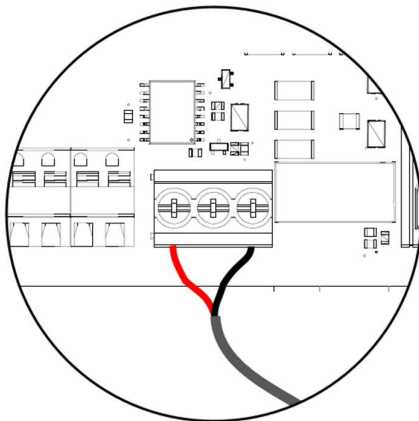

If the eSense input is provided using an external volt-free contact then this must be connected to the outer terminals marked “24V out” and “in”

If the eSense signal is provided by using an external voltage this must be connected to the two right hand terminals marked “24-230V AC/DC in”

There is no need to earth the eSense cable

Wiring Overview Diagram

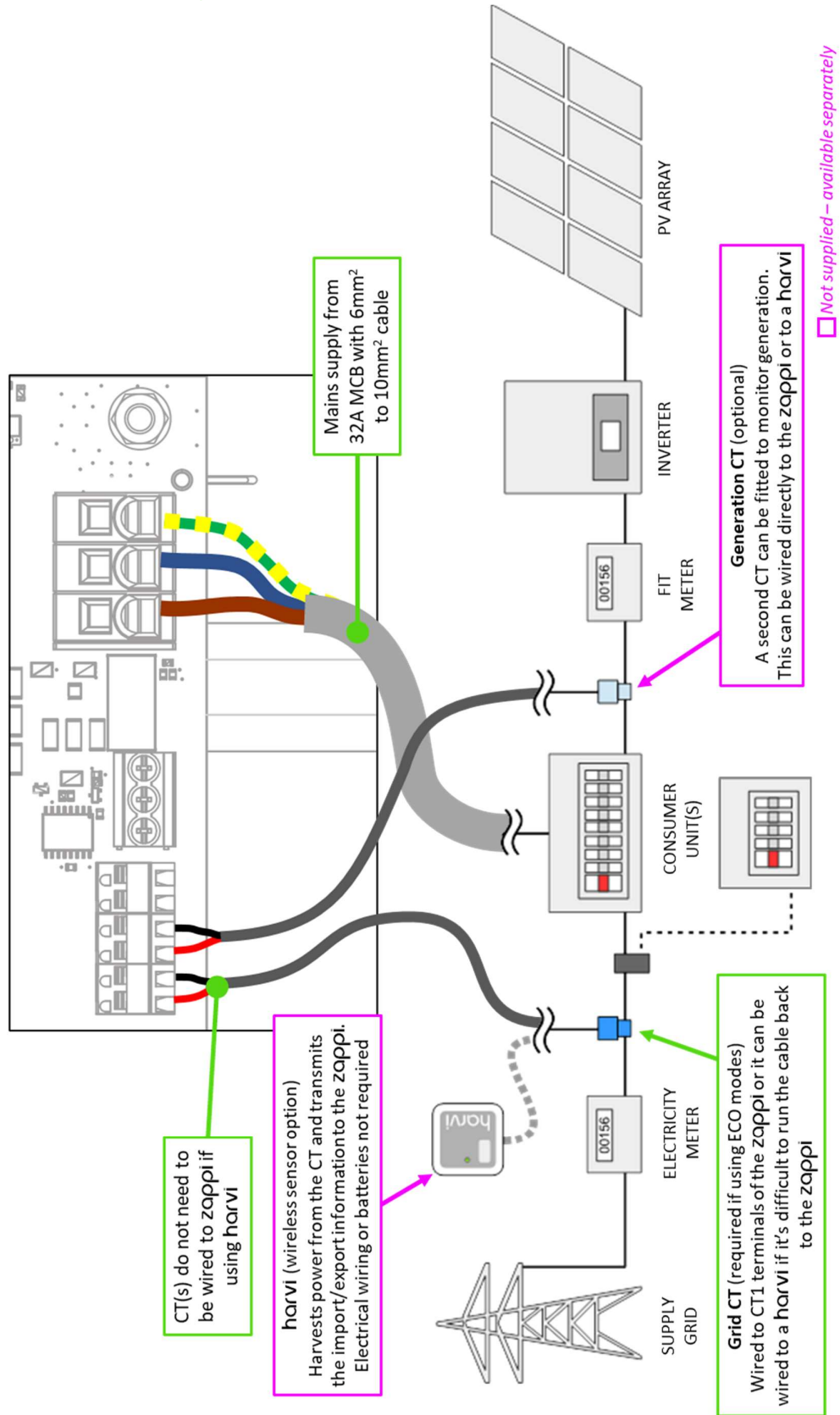

CT Sensor Installation

Current Transformers (CTs) are used to measure current at various places of the installation. For example, the Grid connection point, the solar/wind inverter, or a static battery system.

Installation of a CT to monitor the Grid connection point is required for ECO modes. Other CTs are optional and can be purchased separately. The number and location of CTs used within an installation will vary according to the devices installed and the user requirements.

CTs can be wired to any myenergi device with CT inputs (e.g. eddi, zappi or harvi). This allows for flexible installation as a CT can be wired to the nearest device. Ideally the grid CTs should be wired to the *master* device.

Note: The harvi device can be used (wirelessly) if it is not practical to connect any CT to the eddi or zappi.

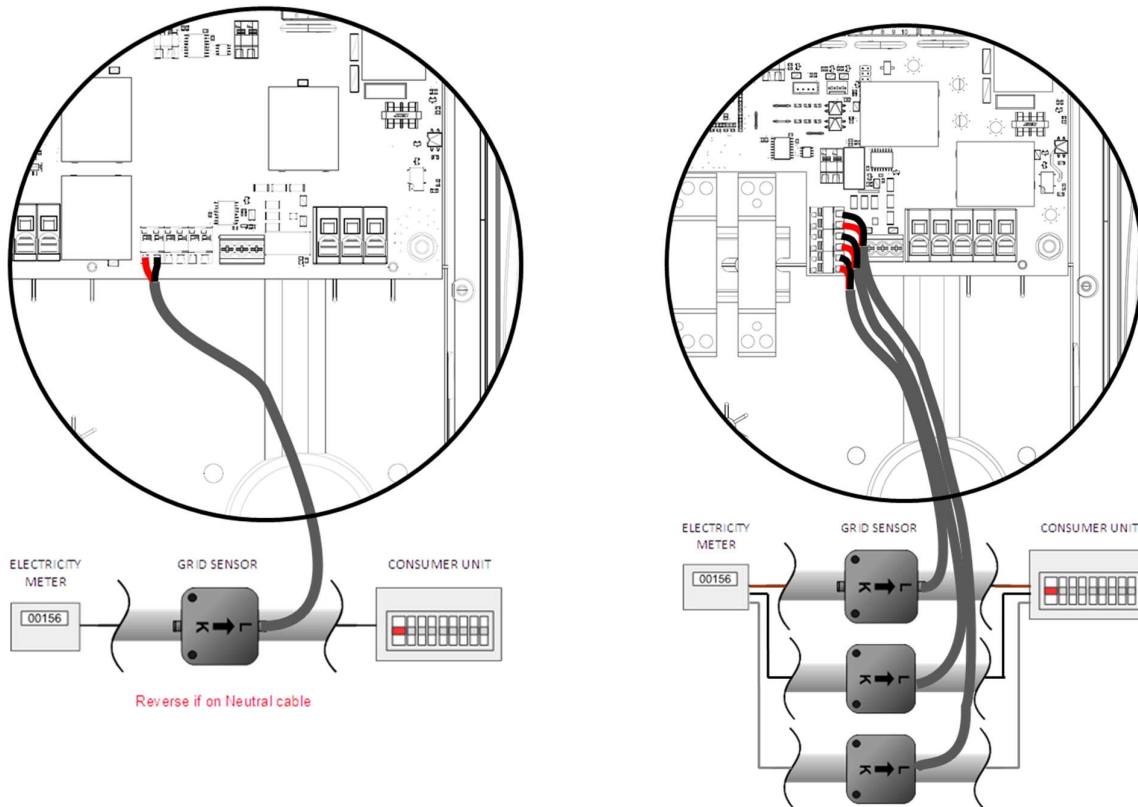

SINGLE PHASE: A CT clamp must be placed around the live meter tail as shown above with the arrow pointing towards the consumer unit

(**Note:** The clamp can be placed on the neutral tail, however the direction of the arrow shown above will need to be in reversed)

3-PHASE: A CT clamp must be placed around each phase with the arrow pointing towards the consumer unit

(**Note:** A CT cannot be clipped on to the neutral in a 3 phase systems)

Once installed the CTs need to be configured. See *CT Config* (page 29) for details of how to configure the CTs.

If using a **single-phase** system, the wired CT sensor (**supplied**) ideally needs to be clipped around the live conductor leaving the meter tail with the arrow (located on the side of the CT) pointing towards the consumer unit. It is possible to use the Neutral conductor, however you will need to reverse the direction of the sensor (arrow towards the meter).

Installation

If using a **3-phase system**, a CT sensor (**supplied**) needs to be clipped around each live tail.

The positioning of the Grid CT sensor is crucial, please take note of the following when deciding where best to install the sensor:

- ✓ The sensor can be connected to any myenergi device with a CT input e.g. the *eddi*, *zappi* (wired sensor) or *harvi* (wireless sensor)
- ✓ **ALL** the import and exported power must be 'seen' by the sensor. Ensure that it is installed before ANY junction box or 'Henley Block' (if necessary, the CT can be fitted inside the consumer unit)
- ✓ There must be only one Grid CT per-phase for the whole installation. (There can be other CTs but only one at the grid connection point. Also note that CTs for third-party devices do not matter)
- ✓ The CTs can be clipped on either the Live or Neutral cable on single-phase systems
Note: On 3 phase system you can only use the Live tails
- ✓ The arrow on the bottom of the CT sensor must be pointing towards the consumer unit (in the direction of grid import) if on the Live cable or reversed if on the Neutral cable (single phase only)
- ✓ Ensure the CT is fully closed and clicks shut
- ✓ Be sure to wire the CT the correct way round: **black [-], red [+]**. Failure to do so will see the import and export readings swapped

Additional CTs

There is an option to add other CT sensors (available separately) for monitoring the generation or other appliances such as battery systems or general loads. Installing a CT for the generator (PV system or wind) will allow the main screen to show the generated power and the total power consumption of all the other appliances in the property.

CTs can also be used to limit the power drawn from the supply. See *Load Balancing / Current Limiting* (page 5147).

- ✓ Additional CTs can be connected to any myenergi device with a CT input that is linked to the network (see Linking Devices on page 3337).
- ✓ The arrow on the bottom of the sensor must be pointing in the direction of normal power flow (e.g. away from the PV inverter) if on the Live cable or reversed if on the Neutral cable.
- ✓ Ensure the sensor is fully closed and clicks shut.
- ✓ Be sure to wire the CT the correct way round: **black [-], red [+]**.

Extending the Sensor Cable

If there is a need to extend the CT cable, **twisted-pair cable like CAT5 must be used**. DO NOT use mains cable, bell wire or speaker cable.

It is important to use only twisted-pair cable to maintain signal integrity. Up to four CT cables can be extended using the separate twisted pairs in a CAT5 Ethernet cable. The cable can be extended up to 100m.

- **Remember to use a separate twisted pair for each CT**
- When joining CT wires make sure that the ends of the wires are twisted tightly together and joined using crimps, screw terminals or solder.
- Avoid using lever clamp type terminals as these do not provide a reliable connection at very low currents.

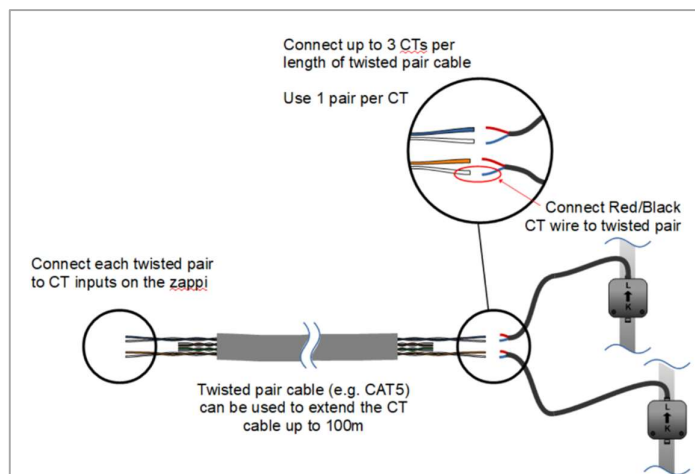

Wireless CT Sensor (optional accessory)

In some cases, it can be difficult or impractical to install a wired sensor. For example, it may be the case that the zappi unit needs to be connected to a sub-board, rather than main consumer unit and two consumer units are in different buildings.

The solution to is to install harvi – a clever device that enables the zappi and eddi products to be installed without using wired CT sensors; instead, the CT sensor is connected to harvi.

Harvi is a patented product and can be viewed www.patents.google.com/patent/GB2562550A/en?assignee=myenergi&oq=myenergi

The harvi does not need batteries or a power supply – the energy from the sensor is harvested and used to transmit the measured signal to the zappi or eddi. This means batteries or electrical wiring are eliminated!

Up to 3 CT sensors may be used with harvi and it also supports 3-phase systems if three sensors are connected.

Refer to the harvi installation guide for details on installing and configuring harvi for your system.



CT Golden Rules

Grid CT

- Only **ONE** Grid CT per phase (check for only one ~ symbol in **Linked Devices Info**).
- Positioned to 'see' ALL import and ALL export current (i.e. always upstream of any junction box).
- Must be on the same phase as the *master* myenergi device.

All CTs

- Arrow should point towards the consumer unit.

3-Phase harvi CTs

- When using harvi in 3-phase mode, the CT inputs correspond to the phase number (e.g. CT1 = Phase 1).
- All harvi devices used in a 3-phase property must be set to 3-phase mode

CT can dos

- ✓ Can be wired to ANY myenergi device in the network.
- ✓ harvi can be used to make ANY CT wireless¹⁰.
- ✓ The CT cable can be extended up to 100m (must use twisted-pair cable e.g. one pair of CAT5). The CT cable can also be shortened.
- ✓ Can be clipped around two or more conductors feeding appliances of the same type (e.g. two Live cables from two inverters that are on the same phase).
- ✓ Can be in close proximity to other CTs.
- ✓ Wires can be swapped in the device to reverse the direction of the readings (e.g. change import to export).
- ✓ Can be grouped with other CTs of the same type so that the power reading is summed (e.g. east and west solar Generation).
- ✓ Can be used on the Neutral conductor in a single-phase installation (direction of arrow or wires must be reversed).
- ✓ Can be set to none in the zappi menu if you want to exclude the reading.

¹⁰ Although CT's connected to a harvi cannot be used with Monitor Group option

Installation

Fitting the Cover

1

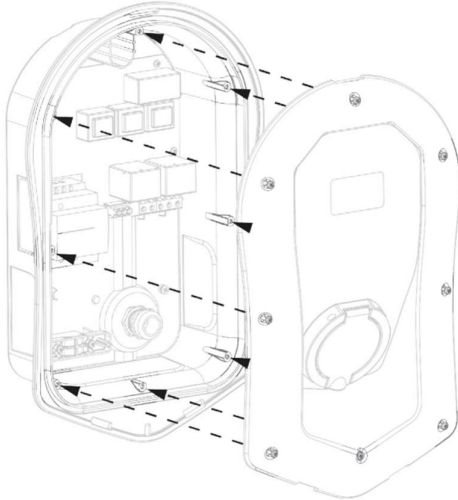

Offer cover to the enclosure, ensuring all cables are neatly secured inside the unit.

- Take particular care that the ribbon cable is not trapped between the cover and the case

Ensure O-ring (seal) is firmly placed into the channel and secure the cover to the unit using the 8 screws that were removed earlier (Torque setting = 1.2Nm).

2

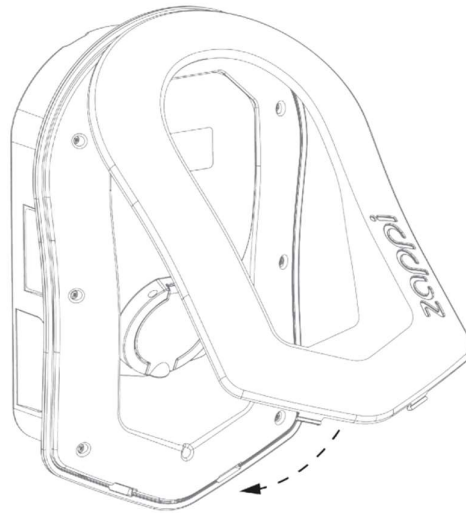

Add fascia to the enclosure cover of the zappi as shown.

3

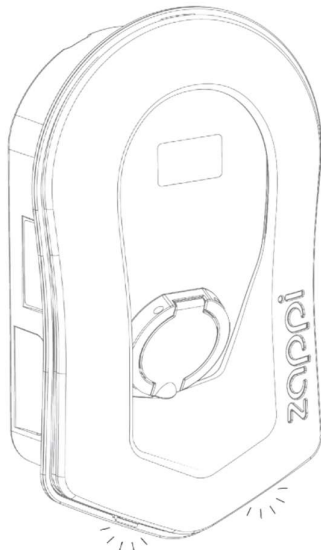

Ensure the 2 tabs at the bottom of the fascia click to indicate its securely fixed in place.

4

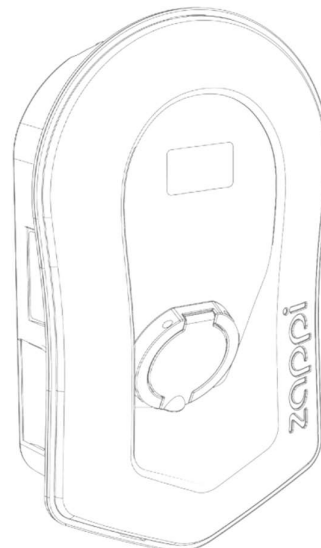

zappi is now ready for operation.

Advanced Installation Options

Load Balancing / Current Limiting / Load Curtailment

CTs can also be used to limit the current drawn by myenergi devices to avoid overloading circuits; this is referred to as load balancing or load curtailment. There are four different ways to limit current and they can be used alone or combined for more complex situations. See the table below:

Function	Operation	Example
Device Limit	Sets a maximum current that can be drawn by the device (e.g. zappi). The current will not be exceeded even during Boost or Fast charge.	A zappi is wired to a 20A supply (rather than 32A). The maximum current drawn will not exceed the set limit (e.g. 20A)
Grid Limit	Sets the limit that can be drawn from the grid connection (i.e. the maximum import current). The zappi and any other linked myenergi device, will limit the current they draw if there is a danger of exceeding the set Grid Limit.	A property may have a grid supply limit of 65A. Several appliances are on, so the property is consuming 12kW (52A). The user wants to charge in FAST mode. Without the Grid Limit set, the total consumption would exceed the allowed import current and trip the supply or blow a fuse. However, with a Grid Limit setting of 60A, zappi would temporarily limit the charging current to 8A (about 1.8kW) and the maximum allowed import current would not be exceeded.
Group Limit (internal CT)	Sets the combined current limit for several myenergi devices.	A property has a large PV array, a swimming pool and two zappis. The supply to the zappis is only rated at 40A so to be safe a Group Limit of 40A is set.
Group Limit (with external CT)	Sets the combined current limit for several myenergi devices that are sharing a supply with another large appliance.	A zappi is installed in a garage which also has a washer and a dryer (2.5kW each). The garage has a supply of 32A coming from the main consumer unit in the house. If all appliances were on together and no limit had been set the total current would exceed the maximum supply current. By setting the Group Limit to 32A an overload will be avoided.

Three-Phase Systems

If the installation has a three-phase supply, you can use the 3 CT connectors either directly connected to the zappi (hard wired) or a harvi device (wireless – optional). We recommend you use one CT per phase; this will allow the zappi to show the total grid import and export figures rather than just one of the phases.

If all three phases are monitored then it is also possible to net the export power across phases, to do this, enable Net Phases in the Supply Grid menu see *Supply Grid - Net Phases* (page 24). This allows the zappi to use surplus power from any phase and not just the phase which the zappi is installed on. However, you must be sure that the electricity is metered in such a way as to allow this.

For a three phase zappi, Net Phases should be turned on.

Battery Storage Systems

AC Coupled

Where there is an AC coupled battery storage system, there can be a conflict as both the storage system and the zappi are competing to consume the surplus energy. Whilst this is not necessarily an issue, the results can be somewhat unpredictable.

There is the option to add an additional CT sensor to monitor the battery storage. This will give control as to which device has priority. The additional CT sensor should be wired to one of the CT terminals in the zappi or harvi device (if wireless measurement is required). This CT should be clipped around the live cable of the battery inverter with the arrow on the CT pointing away from the battery and towards the consumer unit/fuse board.

During the setup process it will be necessary to change the setting for the appropriate CT to AC Battery; refer to *CT Config* (page 27). Also refer to *Supply Grid - Network Settings - Battery* (page 2826) for information on setting the 'priority' of battery systems.

DC Coupled / Hybrid

Battery systems that charge directly from the solar array and cannot charge from AC are usually referred to as being DC coupled or Hybrid. This type of battery system uses the solar PV inverter to provide power from the batteries, thus it is not possible to differentiate between solar and battery power when using a CT to measure the AC current from the inverter.

Because of this limitation, there are less options for managing the surplus power with this type of battery system. It is usually possible to give priority to the battery by setting an Export Margin in the zappi. A setting of 50W or 100W is recommended. The Export Margin setting is found in the Advanced Settings/Supply Grid menu (See *Export Margin* on page 27).

Third-Party Diverters

Some properties have a third-party energy diverter installed and you may want the zappi to take priority (when consuming surplus power) over the diverter. This is possible by installing an extra CT to monitor the diverter. The CT should be clipped around the Live cable of the supply feeding the diverter. The arrow on the CT should be pointing away from the diverter (towards the consumer unit). Wire the CT to the nearest myenergi device or use a harvi if a wireless connection is needed.

Configure the CT Type as Storage Only. See *CT Config* (page 2927) for details of how to configure CTs.

Voltage Optimisers

If there is a voltage optimiser (VO) installed in the property, the CT sensor and the zappi must both be on the same side of the VO; either the incoming grid supply or the optimised supply.

Built-in Protection

zappi has a number of protection features built into the device to make it safe and simple to install.

RCD Protection

The RCD (Residual Current Device) will trip the output from zappi if there is an electrical fault to ground. The RCD is similar to the protective devices found in most domestic consumer units (the “fuse box”) but the standards for electric vehicle charging require additional protection for small DC leakage currents. zappi provides this protection in accordance with EN 62955 (Integral 30mA Type A RCD + 6mA DC leakage protection). Local wiring regulations should be checked to confirm whether an additional upstream RCD is also required.

If there is an electrical fault to ground and the RCD operates the zappi display will show RCD Tripped!

To reset the zappi, make sure that the fault has been removed and then press the  button for three seconds.

Loss of PEN Conductor

The Protective Neutral and Earth (PEN) conductor refers to part of the electricity cable to the property. If this conductor is damaged there is a danger that the chassis of the electric vehicle being charged will become “live” and cause an electric shock. BS7671:2018 Amendment 1:2020 part 722.411.4.1 requires that extra protection is provided to prevent an electric shock – either by fitting an extra earth electrode or through a device which detects the fault and disconnects the supply.

zappi has this protection built-in¹¹ and will disconnect the output if it detects a problem with the PEN conductor or detects that there may be any electric current flowing through the chassis of the EV. This built-in protection means that there is no need to install an earth electrode with the zappi.

If zappi detects a problem with the PEN conductor then the display will show PEN Fault!

To reset the zappi, check the continuity of the earth cable and then press the  button for three seconds.

Loss of Protective Earth

zappi can measure the continuity of the protective earth conductor (the earth wire) on the supply cable. If the earth is disconnected or has a high impedance, then zappi will trip and the display will show PE not connected!

To reset the zappi, make sure that the fault has been removed and then press the  button for three seconds.

Welded Contact

zappi includes protection to make sure that the supply to an EV is disconnected if there is a problem with the circuit breaker. This includes a situation where the contacts on the breaker are welded together. This is a specific requirement of the Renault “Z.E. Ready” and ASEFA “EV Ready” standards (e.g. requirement for Nissan).

If zappi detects a problem with a welded contact, then the display will show RLY WELDED!

If this happens and the fault cannot be reset by pressing the  button for three seconds, then please contact myenergi technical support at support@myenergi.com.

¹¹ Patent Reference GB3577354

Built-in Protection

Over-current

If there is a problem with the equipment on the EV which charges the vehicle's battery, too much current may be drawn from the supply. If this happens, zappi cannot control the charge rate as expected and it could lead to problems with overheating or tripping the main circuit breaker to the zappi.

zappi provides additional protection in accordance with the EV Ready standard by opening its built-in contactor and isolating the EV if it detects that the vehicle is drawing more than 125% of the maximum current communicated to it by the zappi.

If zappi detects an over-current, then the display will show Over Current!

To reset the zappi, make sure that the fault has been removed and then press the  button for three seconds

Over and Under-voltage

zappi will also isolate the supply to the EV if it detects a problem with the electricity supply voltage. The nominal supply voltage is 230V but zappi will trip the output if the measured voltage is more than 12% above or below this level for five seconds.

The zappi display will show Over Voltage! or Under Voltage!

zappi, will reset automatically once the voltage returns to the acceptable range (nominally 230V +/-10%)

Thermal Limit

zappi also includes protection against overheating. If zappi gets too warm it will attempt to reduce the current being drawn by reducing the EV charge rate. If this happens you will see the  icon on the main display.

If the problem continues and the zappi's internal temperature continues to rise, then it will trip the output to the EV, and the display will show **Overheating!**

zappi will resume normal operation once the temperature drops.

Setup

Switching On

After completing and checking the wiring of the supply and the current transformers (CTs), switch on the zappi via the circuit breaker. zappi will start-up and the main screen will be presented after a few seconds.

If zappi has been installed alongside another zappi unit or another myenergi device, refer to *Linking Devices* section for guidance on pairing devices. Also refer to the instruction documentation for the other devices.

Testing

Before leaving site, it is important that a few checks are carried out, ensuring the sensors have been correctly installed and are functional.

1. Check that the time and date are correct and are displayed on the bottom left of the main screen. If they are not present or are incorrect, set the correct time and date in the Other Settings/Time & Date menu option.
2. Check that the EV will charge in FAST mode.
3. Check the Grid Power reading at the top right of the main screen is showing sensible readings and the direction of power flow is as expected.
4. With the EV plugged in, switch to ECO mode and check that the charge power is at minimum (about 1.4kW) OR that it is 'tracking' the surplus power (i.e. the Grid Power reading is 0.0kW)
5. If a Generation CT has been installed, check that the generated power is shown in the top left of the main screen. If the generation reading is missing, the most likely cause is the associated CT input is not enabled – see Ct Config on page 2927.

If a (!) symbol is displayed in the top left-hand corner then the generation CT needs to be reversed.

If the Grid Sensor is wired to a harvi ensure the device settings are set correctly

Remember - only one CT (or three phase set of CT's) can be set to Grid

For details on enabling vHub and WiFi see separate vHub Manual.

Troubleshooting

Troubleshooting

Symptom	Cause	Solution
Display is blank	<ul style="list-style-type: none">- There is no power to the unit	<ul style="list-style-type: none">- Check for correct supply voltage at the supply screw terminals (220 - 260V AC)
In ECO+ mode, the charge does not start, the display is always showing Waiting for Surplus and the export power is 0W	<ul style="list-style-type: none">- Grid Sensor incorrectly installed- Faulty Grid Sensor- No signal from harvi (if used)	<ul style="list-style-type: none">- Check the grid sensor is connected to a CT terminal in the zappi or any CT input in the harvi- Check the Grid CT sensor is installed on the correct cable (see CT Sensor Installation on page 47)- Check resistance of the sensor - it should be around 200Ω when not connected (remove the sensor from the cable before testing resistance)- If using harvi, check that the CT input has been set to Grid in the harvi settings (under Linked Devices / Devices in the zappi Advanced Settings menu)
In ECO+ mode, the charge does not start, the display is always showing Waiting for Surplus , yet the export power is showing correctly	<ul style="list-style-type: none">- Export Margin set too high	<ul style="list-style-type: none">- Check Export Margin setting (default is 0W)
Generation power is always 0kW	<ul style="list-style-type: none">- Generation CT not installed	<ul style="list-style-type: none">- Install generation sensor and connect to one of the CT inputs- Alternatively, if there is no Generation CT, the Generation and House consumption figures can be hidden on the main screen by changing the Icons setting in the Settings / Display & Sound menu
Installation Limit ! displayed Display will show the phase(s) that is(are) overloaded and the prospective current that would be drawn if the zappi were allowed to start charge at the minimum current	<ul style="list-style-type: none">- The measured Grid Current is greater than the Grid Limit set in the zappi	<ul style="list-style-type: none">- Check the Grid Limit setting- Reduce the load in the property- In a three phase installation, consider rebalancing the property load across the three phases
Installation Limit ! CT displayed	<ul style="list-style-type: none">- The Grid CT has become disconnected or is not clamped correctly around the grid supply cable	<ul style="list-style-type: none">- Check CT is installed correctly.

Faults

If any of the following fault messages are displayed, follow the action described.

Displayed Message	Description	Action
Unknown Cable !	<p>zappi has detected an unknown EV cable (untethered units only)</p> <p>Make sure you are using genuine IEC 62196-2 compliant plugs.</p> <p>Range supported: 32A, 20A and 13A.</p>	<p>zappi will automatically retest the cable after 5 seconds.</p> <p>If the issue persists, unplug the cable check for dirt in the plug and try again.</p>
Pilot problem !	<p>zappi has detected an issue with the “Control Pilot” signal on the cable between the zappi and the EV.</p>	<p>zappi will automatically retest the cable after 5 seconds.</p> <p>If the issue persists unplug the cable, check for dirt in the plug and try again.</p>
Lock Failure ! Fault code 23	<p>The socket lock actuator couldn't lock/unlock the inserted plug as expected (untethered units only).</p>	<p>This message can happen when the plug is not fully inserted or if it is twisted or pulled from the socket.</p> <p>Push the plug fully into the zappi to release the plug, then press and hold the  button to reset the unit.</p>
Output Fault ! Fault code 24	<p>zappi has detected a wrong output voltage. e.g. a voltage has been detected when it should be off.</p>	<p>Unplug the EV, press and hold the  button to reset the unit.</p>
PE Fault ! Fault code 25	<p>zappi has detected a problem with the main earth connection to the unit. The earth is either disconnected or the impedance of the earth connection is too high.</p>	<p>Unplug the EV, check the earth connection to the zappi and then hold the  button to reset the unit.</p> <p>If the electricity supply is “IT earthed” check the Supply Grid / Earthing menu setting.</p>
Comms Fault ! Fault code 26	<p>zappi has detected an issue with the built-in protection components.</p>	<p>Unplug the EV, press and hold the  button to reset the unit.</p>
SelfTest Failed ! Fault code 27	<p>The built-in protection devices couldn't be tested or failed the test prior to a charge.</p>	<p>Unplug the EV, press and hold the  button to reset the unit.</p>
Contactor Fault ! Fault code 28	<p>The relay inside the zappi has a welded contact. The secondary relay is open to make sure that the supply to the EV is isolated.</p>	<p>Unplug the EV, press and hold the  button to reset the unit.</p>
RCD Tripped ! Fault code 29	<p>The internal Earth leakage protection has tripped.</p>	<p>Unplug the EV, make sure that the fault has been removed then press and hold the  button to reset the unit.</p>
PEN Fault! Fault code 29	<p>The internal protection against the loss of the PEN conductor on the electricity supply has tripped.</p>	<p>Unplug the EV, make sure that the fault has been removed then press and hold the  button to reset the unit.</p>
Overload ! Fault code 30	<p>The EV is drawing too much current - the output is switched off.</p>	<p>Unplug the EV, press and hold the  button to reset the unit.</p>

Troubleshooting

Bad Voltage Range ! Over Voltage! Under Voltage! Fault code 31	zappi has detected that the supply voltage is too high/low and has disconnected the EV to protect it.	Unplug the EV, make sure that the fault has been removed and hold the ⌵ button to reset the unit.
Overheating!	The zappi unit is too hot – the output is switched off.	Make sure that the zappi is properly ventilated (e.g. has not been covered). Charge will resume once the unit has cooled down again.
Voltage Mismatch ! Fault code 32	The output voltage detected by zappi and the built-in protection components is not the same.	Unplug the EV, press and hold the ⌵ button to reset the unit
Charge Blocked !	zappi has detected that the EV has repeatedly tried to start a charge even though the EV has previously reached “Charge Complete” i.e. The battery is full, the battery has reached a charge level set in the EV, or the charge has been stopped by a timer in the EV.	Unplug the EV Charging will continue when the EV is plugged in again

If any of the above faults persist then stop using your zappi and contact your supplier or myenergi technical support at support@myenergi.com.

Warranty

Full details of the myenergi product warranty are available on our web site or by using this QR code.



<https://myenergi.com/product-warranty/>

Product Registration

Please register your new myenergi devices at <https://myenergi.com/product-registration/>

Technical Specifications

Performance

Mounting Location	Indoor or Outdoor (permanent mounting)
Charging Mode	Mode 3 (IEC 61851-1 compliant communication protocol)
Display	Graphical backlit LCD
Front LED	Multicolour, according to charge status, current and user setting
Charging Current	6A to 32A (variable)
Dynamic Load Balancing	Optional setting to limit current drawn from the unit supply or the grid
Charging Profile	3 charging modes: ECO, ECO+ or FAST. STOP is a further option
Connector Type	Type 2 tethered cable (6.5m) or type 2 socket with locking system
Compliance	LVD 2014/35/EU, EMC 2014/30/EU, EN 62196-2:2017, IEC 62955:2018, ROHS 2011/65/EU, CE Certified, EN 61851-1:2019*

** zappi complies fully with EN 61851-1:2019 with the exception of Clause 8.4 in order to meet the requirements of BS 7671:2018 Amendment 1:2020 which requires the protective earth conductor to be switched in order to provide protection against a damaged PEN conductor in a TN-C-S earthed electrical system.*

Electrical Specifications

Rated Power	7kW (1-phase) or 22kW (3-phase)
Rated Supply Voltage	230V AC Single Phase or 400V AC 3-Phase (+/- 10%)
Supply Frequency	50Hz
Rated Current	32A max
Standby Power Consumption	3W
Earth Leakage Protection	Integral 30mA Type A RCD + 6mA DC protection (RDC-PD in accordance with IEC 62955)
Economy Tariff Sense Input	230V AC sensing (4.0kV isolated)
Wireless Interface	868 MHz / 915 MHz (-A units) proprietary protocol for wireless sensor and remote monitoring options
Grid Current Sensor	100A max. primary current, 16mm max. cable diameter
Supply Cable Entry	Rear / Bottom / Left side / Right side

Technical Specifications

Mechanical Specifications

Enclosure Dimensions	439 x 282 x 122mm	
Protection Degree	IP65 (weatherproof)	
Enclosure Material	ASA 6 & 3mm (UL 94 flame retardant) colours: white RAL 9016 and grey RAL 9006	
Operating Temperature	-25°C to +40°C	
Fixing Points	In-line vertical mounting holes	
Weight	Single Phase Untethered: 3.0kg	Three Phase Untethered: 3.3kg
	Single Phase Tethered: 5.5kg	Three Phase Tethered: 7.2kg

Connectivity

WiFi 2.4 GHz 802.11BGN Connection up to 150 Mbps
WiFi Frequency Range 2412-2484 MHz
Radio Frequency Range 868-870MHz
Radio Frequency (Australia) 915MHz

Max Transmitted Power

Radio	25mW
WiFi	100mW

Charging Modes

STOP	All charging is stopped. zappi will not charge the EV, Boosts (manual, smart and scheduled) are also disabled.
ECO	Charge power is continuously adjusted in response to changes in generation or power consumption elsewhere in the home. Charging will continue until the vehicle is fully charged, even if power is drawn from the grid.
ECO+	Charge power is continuously adjusted in response to changes in generation or power consumption elsewhere in the home. Charging will pause if there is too much imported power, continuing only when there is sufficient surplus power available.
FAST	In this mode, the vehicle will be charged at maximum power. This is just like an ordinary Mode 3 charging point.

Model Variants

Model No.	Rating	Connector	Colour
ZAPPI-2H07UW	7kW	Untethered	White
ZAPPI-2H07TW	7kW	Tethered	White
ZAPPI-2H07UB	7kW	Untethered	Black
ZAPPI-2H07TB	7kW	Tethered	Black
ZAPPI-2H22UW	24kW (3-Phase)	Untethered	White
ZAPPI-2H22TW	24kW (3-Phase)	Tethered	White
ZAPPI-2H22UB	24kW (3-Phase)	Untethered	Black
ZAPPI-2H22TB	24kW (3-Phase)	Tethered	Black

Designed to permit installations compliant with IET Wiring Regulations BS 7671:2018 Amendment 1:2020 and the Electricity Safety, Quality, and Continuity Regulations 2002 and BS 8300:2009+A1:2010.

Technical Specifications

myaccount

Register your myenergi devices, track your energy usage, make the most of flexible and “time of use” tariffs and much more at the myenergi online account myaccount.myenergi.com.



The myenergi app

We have a myenergi app for iPhone and Android devices. This allows you to control and monitor your zappi and other myenergi devices.

The app is free to download and use and is available from the appropriate app store.

Please check on our web site (www.myenergi.com) for more details.

The myenergi forum

We also have a very active user forum at www.myenergi.info

This is where our customers and installers share their experiences, provide advice to each other on getting the best out of their myenergi products and share their ideas for future product development.

We also post details of firmware updates on this forum and provide answers to the questions raised.

Technical Support

If you experience any issues with your zappi during or post installation, please contact our technical support team by scanning the QR Code below



<https://myenergi.com/manual-support/>



Please contact us directly for the quickest solution.

Declaration of Conformity

Hereby, myenergi declares that the radio equipment type zappi eco-smart EV charge point is in compliance with Directive 2014/53/EU.

The full text of the EU declaration of conformity is available at the following internet address scan the QR code below.



<https://myenergi.com/declaration-of-conformity/>

This is your unique product identification

Please use the space inside the back cover of this manual to record the details of your installation and keep this information safe.

Make sure you register your new zappi at myaccount.myenergi.com
and also have a look at the myenergi app



myenergi

Designed and manufactured in the UK by
myenergi Ltd, Pioneer Business Park, Faraday way,
Stallingborough, Grimsby, DN41 8FF

T: +44 (0)333 300 1303
E: sales@myenergi.com
W: myenergi.com